



Online Data Sheet

Encoder WDGI 58C

www.wachendorff-automation.com/wdgi58c

Wachendorff Automation

... systems and encoders

- Complete systems
- Industrial rugged encoders to suit your application
- Standard range and customer versions
- Maximum permissible loads
- 48-hour express production
- Made in Germany
- Worldwide distributor network

Encoder WDGI 58C



- Rugged industrial standard encoder
- Housing cap die cast aluminum, with particularly eco-friendly powder coating
- Up to 25000 PPR by use of high grad electronics
- Protection to IP67, shaft sealed to IP65
- High noise immunity
- Full connection protection with 10 VDC up to 30 VDC
- High output frequency 600 kHz/2 MHz
- Optional: -40 °C up to +85 °C, Pressure equalising membrane

www.wachendorff-automation.com/wdgi58c

Resolution

Max. pulses per revolution up to 25000 PPR
PPR

Mechanical Data

Housing

Flange	synchro flange
Flange material	aluminum
Housing cap	die cast aluminum, powder coated
Housing	Ø 58 mm
Cam mounting	pitch 69 mm

Shaft(s)

Shaft material	stainless steel
Starting torque	approx. 1 Ncm at ambient temperature

Shaft	Ø 10 mm
Shaft length	L: 20 mm
Max. Permissible shaft loading radial	200 N
Max. Permissible shaft loading axial	120 N

Bearings

Bearings type	2 precision ball bearings
Nominale service life	1 x 10 ⁹ revs. at 100 % rated shaft load 1 x 10 ¹⁰ revs. at 40 % rated shaft load 1 x 10 ¹¹ revs. at 20 % rated shaft load
Max. operating speed	8000 rpm

Machinery Directive: basic data safety integrity level

MTTF _d	200 a
Mission time (TM)	25 a
Nominale service life (L10h)	1 x 10 ¹¹ revs. at 20 % rated shaft load and 8000 rpm
Diagnostic coverage (DC)	0 %

Electrical Data

Power supply/Current consumption	4,75 VDC up to 5,5 VDC: typ. 100 mA
Power supply/Current consumption	5 VDC up to 30 VDC: typ. 70 mA
Power supply/Current consumption	10 VDC up to 30 VDC: typ. 100 mA
Output circuit	TTL TTL, RS422 compatible, inv. HTL HTL, inv. 1 Vpp sin/cos

Pulse frequency	TTL 5000 ppr: max. 200 kHz HTL 5000 ppr: max. 200 kHz TTL more than 1200 ppr: max. 2 MHz HTL more than 1200 ppr: max. 600 kHz 1 Vpp sin/cos: max. 100 kHz
Channels	AB ABN and inverted signals
Load	max. 40 mA / channel @ 1 Vpp sin/cos: min. 120 Ohm
Circuit protection	circuit type F24, G24, H24, I24, P24, R24 only

Accuracy

Phase offset	90° ± max. 7.5 % of the period duration
pulse-/pause-ratio	5000 ppr: 50 % ± max. 7 % Output circuits F24, P24, F05, P05, 645: 50 % ± max. 10 %

General Data

Weight	approx. 230 g
Connections	cable or connector outlet
Protection rating (EN 60529)	Housing: IP65, IP67; shaft sealed: IP65
Operating temperature	Connector: -40 °C up to +85 °C, cable: -20 °C up to +80 °C, (Option ACA: -40 °C up to +85 °C) 1 Vpp: -10 °C up to +70 °C
Storage temperature	Connector: -30 °C up to +85 °C, cable: -30 °C up to +80 °C, option ACA: -40 °C up to +85 °C

More Information

General technical data and safety instructions
<http://www.wachendorff-automation.com/gtd>

Options
<http://www.wachendorff-automation.com/acc>

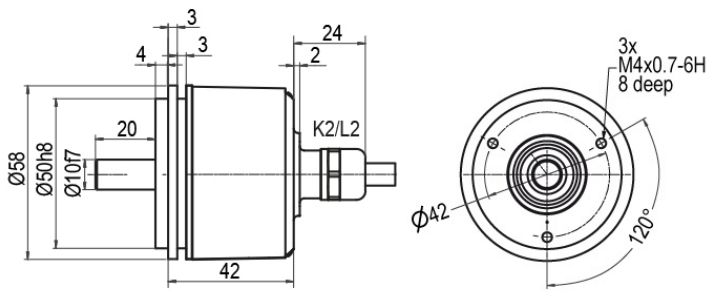
WDGI 58C: Cable connection K2, L2, axial, with 2 m cable

Description
ABN inv. poss.

K2	axial, shield not connected	•
L2	axial, shield connected to encoder housing	•

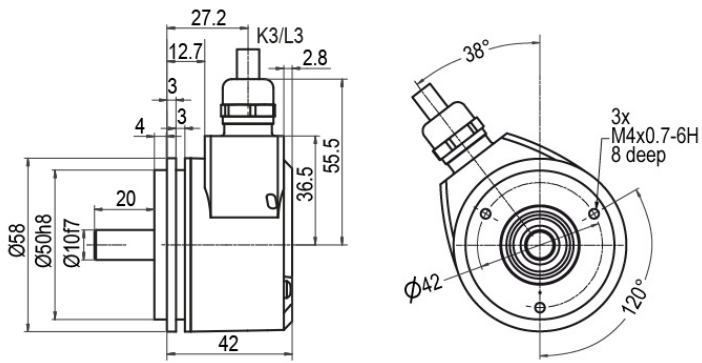
Assignments					
	K2, L2	K2, L2	K2, L2	K2, L2	L2
Circuit	G05, G24	F05, H05, F24, H24, H30	I05, I24, 524	P05, R05, P24, R24, 245, 645, R30	SIN
GND	WH	WH	WH	WH	WH
(+) Vcc	BN	BN	BN	BN	BN
A	GN	GN	GN	GN	GN
B	YE	YE	YE	YE	GY
N	GY	GY	GY	GY	-
Light reserve warning	PK	-	PK	-	-
A inv.	-	-	RD	RD	YE
B inv.	-	-	BK, (BU at ACA)	BK, (BU at ACA)	PK
N inv.	-	-	VT	VT	-
Shield	flex	flex	flex	flex	flex

WDGI 58C: Cable connection K3, L3, radial, with 2 m cable

Description
ABN inv. poss.
K3 radial, shield not connected

•

L3 radial, shield connected to encoder housing







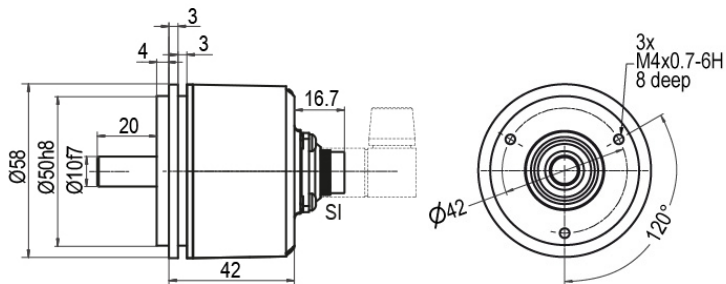



•

Assignments

	K3, L3	K3, L3	K3, L3	K3, L3	L3
Circuit	G05, G24	F05, H05, F24, H24, H30	I05, I24, 524	P05, R05, P24, R24, 245, 645, R30	SIN
GND	WH	WH	WH	WH	WH
(+) Vcc	BN	BN	BN	BN	BN
A	GN	GN	GN	GN	GN
B	YE	YE	YE	YE	GY
N	GY	GY	GY	GY	-
Light reserve warning	PK	-	PK	-	-
A inv.	-	-	RD	RD	YE
B inv.	-	-	BK, (BU at ACA)	BK, (BU at ACA)	PK
N inv.	-	-	VT	VT	-
Shield	flex	flex	flex	flex	flex

WDGI 58C: Connector (M16x0.75) SI, axial, 5-, 6-, 8-, 12-pin

Description	ABN inv. poss.
SI5 axial, 5-pin, Connector connected to encoder housing	-
SI6 axial, 6-pin, Connector connected to encoder housing	-
SI8 axial, 8-pin, Connector connected to encoder housing	•
SI12 axial, 12-pin, Connector connected to encoder housing	•

Assignments											
	SI5	SI6	SI6	SI8	SI8	SI8	SI12	SI12	SI12	SI12	SI12
	5-pin	6-pin	6-pin	8-pin	8-pin	8-pin	12-pin	12-pin	12-pin	12-pin	12-pin
											
Circuit	F05, H05, F24, H24, H30	G05, G24	F05, H05, F24, H24, H30	F05, H05, F24, H24, H30	P05, R05, P24, R24, R30, 245, 645	SIN	G05, G24	F05, H05, F24, H24, H30	I05, I24, 524	P05, R05, P24, R24, 245, 645, R30	SIN
GND	1	6	6	1	1	1	K, L	K, L	K, L	K, L	K, L
(+) Vcc	2	1	1	2	2	2	M, B	M, B	M, B	M, B	M, B
A	3	2	2	3	3	3	E	E	E	E	E
B	4	4	4	4	4	4	H	H	H	H	H
N	5	3	3	5	5	-	C	C	C	C	-
Light reserve warning	-	5	-	-	-	-	G	-	G	-	-
A inv.	-	-	-	-	6	6	-	-	F	F	F
B inv.	-	-	-	-	7	7	-	-	A	A	A
N inv.	-	-	-	-	8	-	-	-	D	D	-
n. c.	-	-	5	6, 7, 8	-	5, 8	A, D, F, J	A, D, F, G, J	J	G, J	D, G, J
Shield	-	-	-	-	-	-	-	-	-	-	-

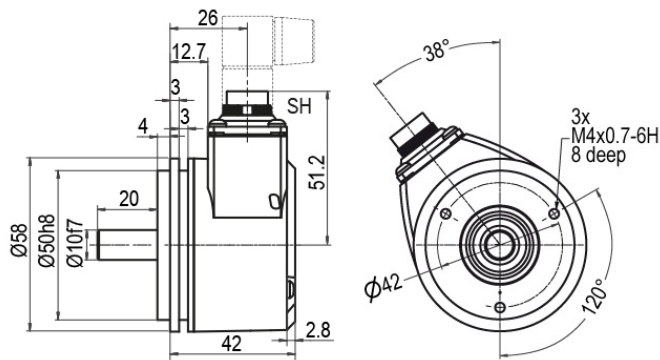
WDGI 58C: Connector (M16x0.75) SH, radial, 5-, 6-, 8-, 12-pin

Description	ABN inv. poss.
SH5 radial, 5-pin, Connector connected to encoder housing	-
SH6 radial, 6-pin, Connector connected to encoder housing	-
SH8 radial, 8-pin, Connector connected to encoder housing	•
SH12 radial, 12-pin, Connector connected to encoder housing	•

Assignments	SH5	SH6	SH6	SH8	SH8	SH8	SH12	SH12	SH12	SH12	SH12
	5-pin	6-pin	6-pin	8-pin	8-pin	8-pin	12-pin	12-pin	12-pin	12-pin	12-pin
Circuit	F05, H05, F24, H24, H30	G05, G24	F05, H05, F24, H24, H30	F05, H05, F24, H24, H30	P05, R05, P24, R24, R30, 245, 645	SIN	G05, G24	F05, H05, F24, H24, H30	I05, I24, 524	P05, R05, P24, R24, 245, 645, R30	SIN
GND	1	6	6	1	1	1	K, L	K, L	K, L	K, L	K, L
(+) Vcc	2	1	1	2	2	2	M, B	M, B	M, B	M, B	M, B
A	3	2	2	3	3	3	E	E	E	E	E
B	4	4	4	4	4	4	H	H	H	H	H
N	5	3	3	5	5	-	C	C	C	C	-
Light reserve warning	-	5	-	-	-	-	G	-	G	-	-
A inv.	-	-	-	-	6	6	-	-	F	F	F
B inv.	-	-	-	-	7	7	-	-	A	A	A
N inv.	-	-	-	-	8	-	-	-	D	D	-
n. c.	-	-	5	6, 7, 8	-	5, 8	A, D, F, J	A, D, F, G, J	J	G, J	D, G, J
Shield	-	-	-	-	-	-	-	-	-	-	-

WDGI 58C: Connector (M16x0.75) S2, axial, 7-pin

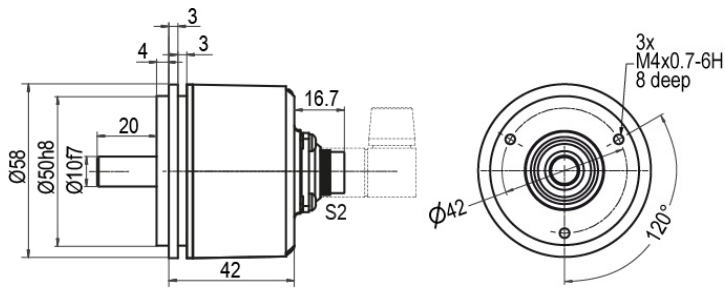

Description

ABN inv. poss.

S2 axial, 7-pin, Connector connected to encoder housing

-

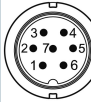
Assignments		
	S2 7-pin	S2 7-pin
		
Circuit	G05, G24	F05, H05, F24, H24, H30
GND	1	1
(+) Vcc	2	2
A	3	3
B	4	4
N	5	5
Light reserve warning	6	-
A inv.	-	-
B inv.	-	-
N inv.	-	-
n. c.	7	6, 7
Shield	-	-

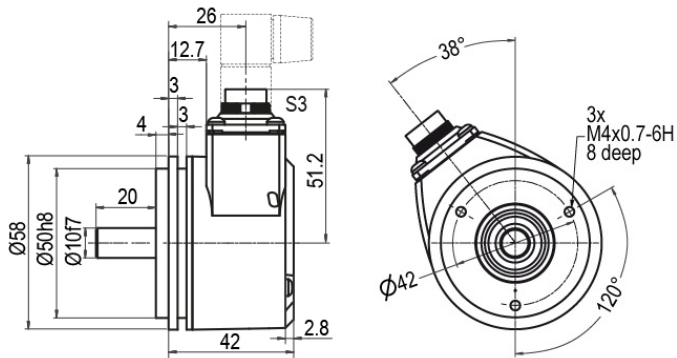
WDGI 58C: Connector (M16x0.75) S3, radial, 7-pin

Description
ABN inv. poss.
S3 radial, 7-pin, Connector connected to encoder housing

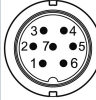
-

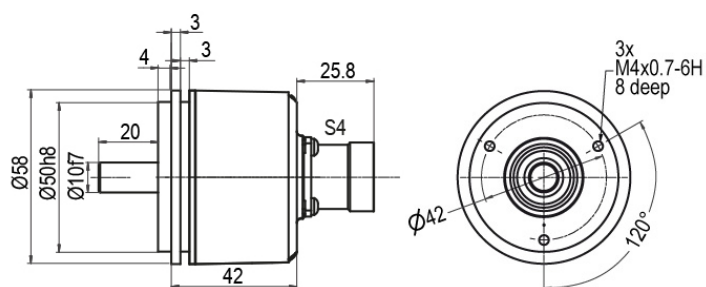
Assignments		
	S3	S3
	7-pin	7-pin
		
Circuit	G05, G24	F05, H05, F24, H24, H30
GND	1	1
(+) Vcc	2	2
A	3	3
B	4	4
N	5	5
Light reserve warning	6	-
A inv.	-	-
B inv.	-	-
N inv.	-	-
n. c.	7	6, 7
Shield	-	-



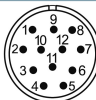
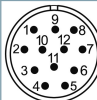
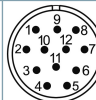
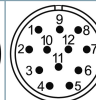
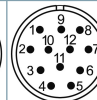

WDGI 58C: Connector (M23) S4, axial, 12-pin

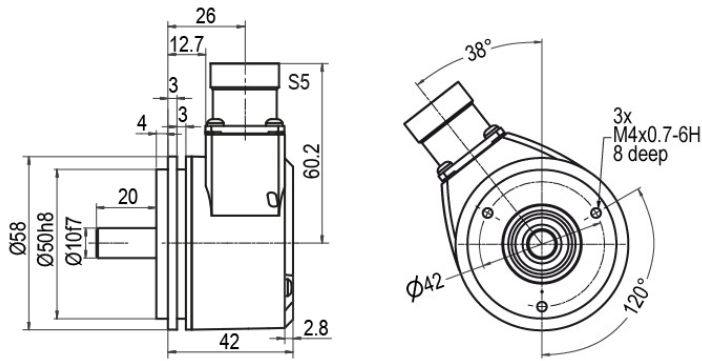
Description
ABN inv. poss.
S4 axial, 12-pin, Connector connected to encoder housing

•

Assignments					
	S4	S4	S4	S4	S4
	12-pin	12-pin	12-pin	12-pin	12-pin
					
Circuit	G05, G24	F05, H05, F24, H24, H30	I05, I24, 524	P05, R05, P24, R24, 245, 645, R30	SIN
GND	10	10	10	10	10
(+) Vcc	12	12	12	12	12
A	5	5	5	5	5
B	8	8	8	8	8
N	3	3	3	3	-
Light reserve warning	11	-	11	-	-
A inv.	-	-	6	6	6
B inv.	-	-	1	1	1
N inv.	-	-	4	4	-
n. c.	1, 2, 4, 6, 7, 9	1, 2, 4, 6, 7, 9, 11	2, 7, 9	2, 7, 9, 11	2, 3, 4, 7, 9, 11
Shield	-	-	-	-	-

WDGI 58C: Connector (M23) S5, radial, 12-pin

Description
ABN inv. poss.
S5 radial, 12-pin, Connector connected to encoder housing

•

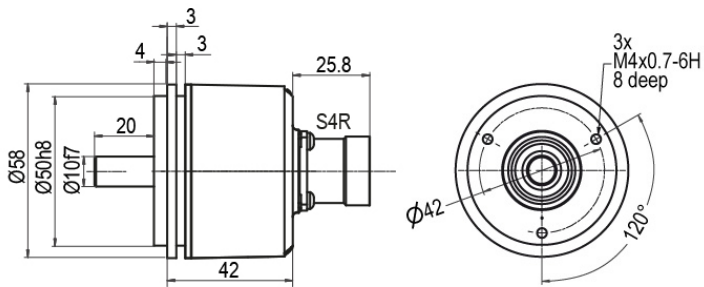
Assignments					
	S5	S5	S5	S5	S5
	12-pin	12-pin	12-pin	12-pin	12-pin
					
Circuit	G05, G24	F05, H05, F24, H24, H30	I05, I24, 524	P05, R05, P24, R24, 245, 645, R30	SIN
GND	10	10	10	10	10
(+) Vcc	12	12	12	12	12
A	5	5	5	5	5
B	8	8	8	8	8
N	3	3	3	3	-
Light reserve warning	11	-	11	-	-
A inv.	-	-	6	6	6
B inv.	-	-	1	1	1
N inv.	-	-	4	4	-
n. c.	1, 2, 4, 6, 7, 9	1, 2, 4, 6, 7, 9, 11	2, 7, 9	2, 7, 9, 11	2, 3, 4, 7, 9, 11
Shield	-	-	-	-	-

WDGI 58C: Connector (M23) S4R, axial, 12-pin (clockwise)

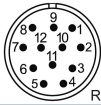
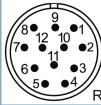
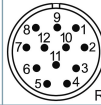
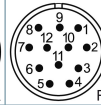
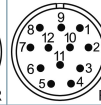
Description
ABN inv. poss.
S4R axial, 12-pin, Connector connected to encoder housing

•

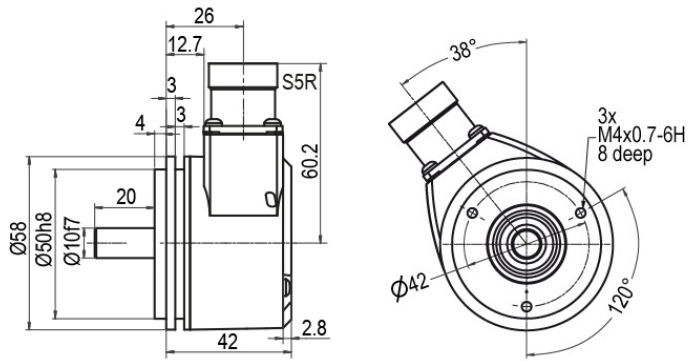
Assignments					
	S4R	S4R	S4R	S4R	S4R
	12-pin	12-pin	12-pin	12-pin	12-pin
					
Circuit	G05, G24	F05, H05, F24, H24, H30	I05, I24, 524	P05, R05, P24, R24, 245, 645, R30	SIN
GND	10	10	10	10	10
(+) Vcc	12	12	12	12	12
A	5	5	5	5	5
B	8	8	8	8	8
N	3	3	3	3	-
Light reserve warning	11	-	11	-	-
A inv.	-	-	6	6	6
B inv.	-	-	1	1	1
N inv.	-	-	4	4	-
n. c.	1, 2, 4, 6, 7, 9	1, 2, 4, 6, 7, 9, 11	2, 7, 9	2, 7, 9, 11	2, 3, 4, 7, 9, 11
Shield	-	-	-	-	-

WDGI 58C: Connector (M23) S5R, radial, 12-pin (clockwise)

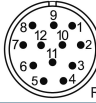
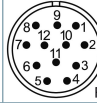
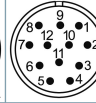
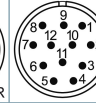
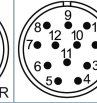
Description
ABN inv. poss.
S5R radial, 12-pin, Connector connected to encoder housing



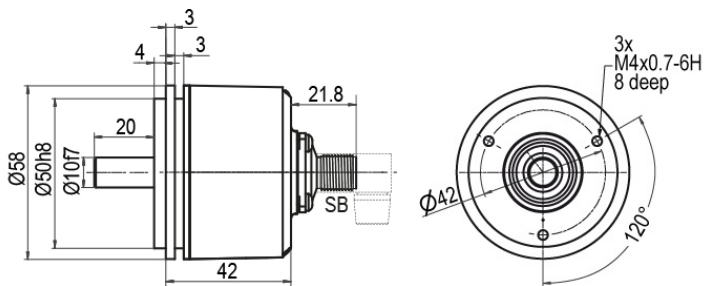





•

Assignments					
	S5R	S5R	S5R	S5R	S5R
	12-pin	12-pin	12-pin	12-pin	12-pin
					
Circuit	G05, G24	F05, H05, F24, H24, H30	I05, I24, 524	P05, R05, P24, R24, 245, 645, R30	SIN
GND	10	10	10	10	10
(+) Vcc	12	12	12	12	12
A	5	5	5	5	5
B	8	8	8	8	8
N	3	3	3	3	-
Light reserve warning	11	-	11	-	-
A inv.	-	-	6	6	6
B inv.	-	-	1	1	1
N inv.	-	-	4	4	-
n. c.	1, 2, 4, 6, 7, 9	1, 2, 4, 6, 7, 9, 11	2, 7, 9	2, 7, 9, 11	2, 3, 4, 7, 9, 11
Shield	-	-	-	-	-

WDGI 58C: Sensor-connector (M12x1) SB, axial, 4-, 5-, 8-, 12-pin

Description
ABN inv. poss.





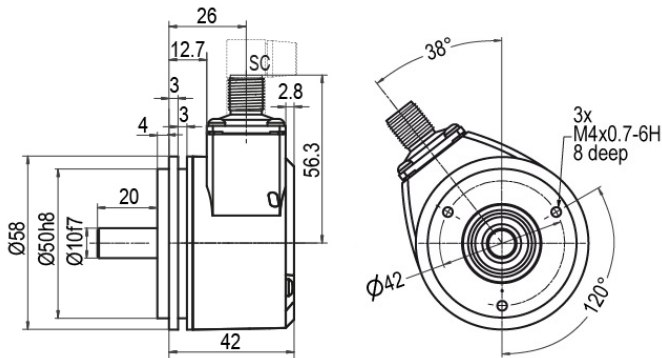



SB4	axial, 4-pin, Connector connected to encoder housing	-
SB5	axial, 5-pin, Connector connected to encoder housing	-
SB8	axial, 8-pin, Connector connected to encoder housing	•
SB12	axial, 12-pin, Connector connected to encoder housing	•

Assignments

	SB4	SB5	SB8	SB8	SB8	SB12	SB12	SB12	SB12
	4-pin	5-pin	8-pin	8-pin	8-pin	12-pin	12-pin	12-pin	12-pin
									
Circuit	F05, H05, F24, H24, H30	F05, H05, F24, H24, H30	F05, H05, F24, H24, H30	P05, R05, P24, R24, R30, 245, 645	SIN	G05, G24	F05, H05, F24, H24, H30	I05, I24, 524	P05, R05, P24, R24, 245, 645, R30
GND	3	3	1	1	1	3	3	3	3
(+) Vcc	1	1	2	2	2	1	1	1	1
A	2	4	3	3	3	4	4	4	4
B	4	2	4	4	5	6	6	6	6
N	-	5	5	5	-	8	8	8	8
Light reserve warning	-	-	-	-	-	5	-	5	-
A inv.	-	-	-	6	4	-	-	9	9
B inv.	-	-	-	7	6	-	-	7	7
N inv.	-	-	-	8	-	-	-	10	10
n. c.	-	-	6, 7, 8	-	7, 8	2, 7, 9, 10, 11, 12	2, 5, 7, 9, 10, 11, 12	2, 11, 12	2, 5, 11, 12
Shield	-	-	-	-	-	-	-	-	-

WDGI 58C: Sensor-connector (M12x1) SC, radial, 4-, 5-, 8-, 12-pin

Description	ABN inv. poss.
SC4 radial, 4-pin, Connector connected to encoder housing	-
SC5 radial, 5-pin, Connector connected to encoder housing	-
SC8 radial, 8-pin, Connector connected to encoder housing	•
SC12 radial, 12-pin, Connector connected to encoder housing	•

Assignments	SC4	SC5	SC8	SC8	SC8	SC12	SC12	SC12	SC12
	4-pin	5-pin	8-pin	8-pin	8-pin	12-pin	12-pin	12-pin	12-pin
									
Circuit	F05, H05, F24, H24, H30	F05, H05, F24, H24, H30	F05, H05, F24, H24, H30	P05, R05, P24, R24, R30, 245, 645	SIN	G05, G24	F05, H05, F24, H24, H30	I05, I24, 524	P05, R05, P24, R24, 245, 645, R30
GND	3	3	1	1	1	3	3	3	3
(+) Vcc	1	1	2	2	2	1	1	1	1
A	2	4	3	3	3	4	4	4	4
B	4	2	4	4	5	6	6	6	6
N	-	5	5	5	-	8	8	8	8
Light reserve warning	-	-	-	-	-	5	-	5	-
A inv.	-	-	-	6	4	-	-	9	9
B inv.	-	-	-	7	6	-	-	7	7
N inv.	-	-	-	8	-	-	-	10	10
n. c.	-	-	6, 7, 8	-	7, 8	2, 7, 9, 10, 11, 12	2, 5, 7, 9, 10, 11, 12	2, 11, 12	2, 5, 11, 12
Shield	-	-	-	-	-	-	-	-	-

Options

Low temperature

The encoder WDGI 58C with the output circuit types F24, G24, H24, I24, P24, R24, F05, G05, H05, I05, P05, R05, 245, 524, 645 is also available with the extended temperature range -40 °C up to +85 °C [-40 °F up to +185 °F] (measured at the flange).

Order key

ACA

Pressure equalising membrane

The WDGI 58C shaft encoder is also optionally available with a pressure equalising membrane. This prevents water from penetrating into the encoder housing in the case of high air humidity.

The IP67 protection level, temperature range and salt spray resistance are maintained. Resistant to chemicals and solvents in accordance with DIN EN ISO 2812-1.

Order key

ACR

Cable length

The encoder WDGI 58C can be supplied with more than 2 m cable. The maximum cable length depends on the supply voltage and the frequency; see www.wachendorff-automation.com/atd

Please extend the standard order code with a three figure number, specifying the cable length in decimetres.

Example: 5 m cable = 050

Order key

XXX = Decimeter

Example Order No.	Type					Your encoder
WDGI 58C	WDGI 58C					WDGI 58C
Shaft						
10	10					
Pulses per revolution PPR:						
5000	2, 5, 10, 15, 20, 24, 25, 30, 36, 40, 48, 50, 60, 64, 72, 87, 90, 100, 120, 125, 127, 128, 150, 160, 180, 200, 216, 236, 240, 250, 254, 256, 300, 314, 320, 360, 400, 500, 512, 571, 600, 625, 720, 750, 768, 800, 810, 900, 1000, 1024, 1200, 1250, 1270, 1440, 1500, 1800, 2000, 2048, 2400, 2500, 2880, 3000, 3600, 4000, 4096, 4685, 5000, 5760, 6000, 7200, 7500, 8192, 10000, 10240, 12000, 12500, 15000, 16384, 20000, 20480, 25000 1 Vpp Sin/Cos only 1024, 2048 Other PPRs on request					
Channels:						
ABN	AB, ABN (SIN: AB)					
Output circuit						
G24	Resolution PPR	Power supply VDC	Output circuit	Light reserve warning	Order key	
	up to 2500	5 - 30	HTL	-	H30	
		5 - 30	HTL inverted	-	R30	
	up to 5000	4.75 - 5.5	TTL	•	G05	
		4.75 - 5.5	TTL	-	H05	
		4.75 - 5.5	TTL, RS422 comp., inverted	•	I05	
		4.75 - 5.5	TTL, RS422 comp., inverted	-	R05	
		10 - 30	HTL	•	G24	
		10 - 30	HTL	-	H24	
		10 - 30	HTL inverted	•	I24	
		10 - 30	HTL inverted	-	R24	
		10 - 30	TTL, RS422 comp., inverted	•	524	
		10 - 30	TTL, RS422 comp., inverted	-	245	
	(higher frequency) 1200 up to 25000	4.75 - 5.5	TTL	-	F05	
		4.75 - 5.5	TTL, RS422 comp., inverted	-	P05	
		10 - 30	HTL	-	F24	
		10 - 30	HTL inverted	-	P24	
		10 - 30	TTL, RS422 comp., inverted	-	645	
	1024, 2048	4.75 - 5.5	1 Vpp sin/cos	-	SIN	

Electrical connections				
Description	ABN inv. poss.	Order key		
Cable: length (2 m standard, WDG 58T: 1 m)				
axial, shield not connected	•	K2	K2	
axial, shield connected to encoder housing	•	L2		
radial, shield not connected	•	K3		
radial, shield connected to encoder housing	•	L3		
Connector: (shield connected to encoder housing)				
connector, M16x0.75, 5-pin, axial	-	SI5		
connector, M16x0.75, 5-pin, radial	-	SH5		
connector, M16x0.75, 6-pin, axial	-	SI6		
connector, M16x0.75, 6-pin, radial	-	SH6		
connector, M16x0.75, 8-pin, axial	•	SI8		
connector, M16x0.75, 8-pin, radial	•	SH8		
connector, M16x0.75, 12-pin, axial	•	SI12		
connector, M16x0.75, 12-pin, radial	•	SH12		
connector, M16x0.75, 7-pin, axial	-	S2		
connector, M16x0.75, 7-pin, radial	-	S3		
connector, M23, 12-pin, axial	•	S4		
connector, clockwise pin count, M23, 12-pin, axial	•	S4R		
connector, M23, 12-pin, radial	•	S5		
connector, clockwise pin count, M23, 12-pin, radial	•	S5R		
sensor-connector, M12x1, 4-pin, axial	-	SB4		
sensor-connector, M12x1, 4-pin, radial	-	SC4		
sensor-connector, M12x1, 5-pin, axial	-	SB5		
sensor-connector, M12x1, 5-pin, radial	-	SC5		
sensor-connector, M12x1, 8-pin, axial	•	SB8		
sensor-connector, M12x1, 8-pin, radial	•	SC8		
sensor-connector, M12x1, 12-pin, axial	•	SB12		
sensor-connector, M12x1, 12-pin, radial	•	SC12		
Options				
Description	Order key			
Low temperature	ACA			
Pressure equalising membrane	ACR			
Without option	Empty			
Cable length	XXX = Decimeter			

Example Order No.=	WDGI 58C	10	5000	ABN	G24	K2			WDGI 58C						Your encoder
---------------------------	----------	----	------	-----	-----	----	--	--	----------	--	--	--	--	--	---------------------



For further information please contact our local distributor.
Here you find a list of our distributors worldwide.
<https://www.wachendorff-automation.com/>



Wachendorff Automation GmbH & Co. KG
Industriestrasse 7 • 65366 Geisenheim
Germany

Phone: +49 67 22 / 99 65 25
Fax: +49 67 22 / 99 65 70
E-Mail: wdg@wachendorff.de
www.wachendorff-automation.de

