

HAM-LET HOSES

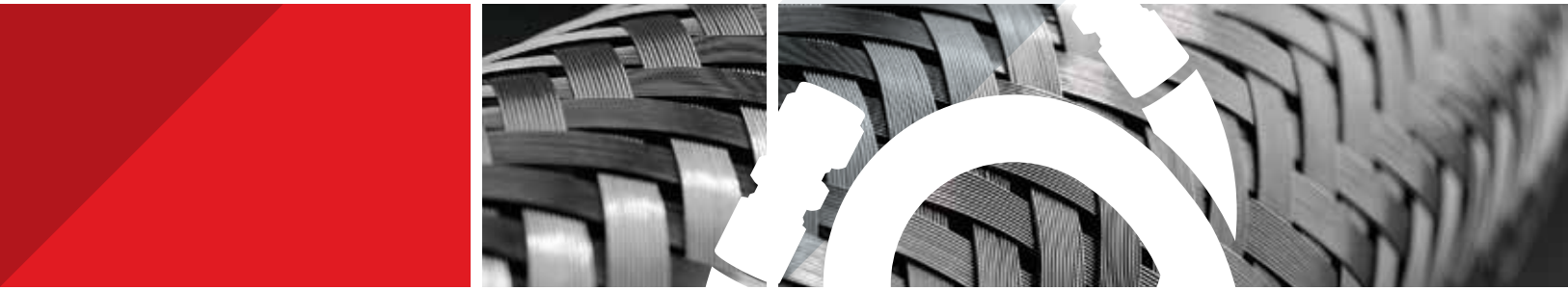

INDEX

HAM-LET Metal Hoses	6	HAM-LET PTFE Hoses - General	20
Selecting & Installing Metal Hose Assemblies	13	PTFE Hoses - Ordering Information	23
Metal Hoses - Ordering Information	18		

Metal Hoses



SHF Series
General use series
Page 8



SHU Series
Ultra high pressure series
Page 9

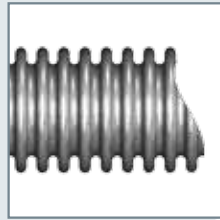

SHV Series
Vacuum/Formable series
Page 10



SHE Series
Extra flexible series
Page 11

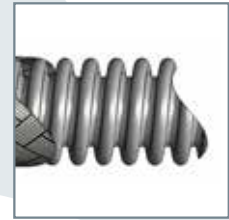

SHH Series
High pressure series
Page 12

PTFE Hoses

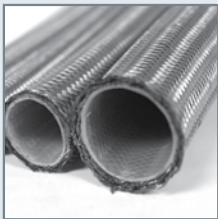

THT Series
Smooth core
Page 21



THS Series
Silicon covered Smooth core
Page 21



THC Series
Convuluted core
Page 22

Expansion Joints



Expansion Joints
All Stainless Steel
Page 22

Hoses End Connections



LET-LOK®



Tube Adapter



ONE-LOK®



UH Line



Male NPT



Male BSPP



Female NPT



Female BSPP



Butt Weld



Male Face Seal Swivel



Female Face Seal Swivel



Male/Female JIC 37° Flare

HAM-LET Hoses Quick Selection Guide

See Ordering information on page 18 and 23

Hose Series	Number of Braids	Inside Diameter inch (mm)															
		1/4 (6.35)		3/8 (9.53)		1/2 (12.70)		3/4 (19.05)		1 (25.40)		1 1/4 (31.75)		1 1/2 (38.10)		2 (50.80)	
		Working Pressure psi (bar)	Dynamic Bend Radius inch (mm)	Working Pressure psi (bar)	Dynamic Bend Radius inch (mm)	Working Pressure psi (bar)	Dynamic Bend Radius inch (mm)	Working Pressure psi (bar)	Dynamic Bend Radius inch (mm)	Working Pressure psi (bar)	Dynamic Bend Radius inch (mm)	Working Pressure psi (bar)	Dynamic Bend Radius inch (mm)	Working Pressure psi (bar)	Dynamic Bend Radius inch (mm)	Working Pressure psi (bar)	Dynamic Bend Radius inch (mm)
SHF General Use Standard Product T321, T316L (See page 458)	0	90 (6)		70 (5)		70 (5)		43 (3)		43 (3)		43 (3)		28 (2)		14 (1)	
	1	1800 (124)	4.5 (114)	1558 (107)	5.0 (127)	1186 (82)	5.5 (140)	898 (62)	8.0 (203)	718 (50)	9.0 (229)	645 (44)	10.0 (254)	531 (37)	11.0 (279)	449 (31)	13.0 (330)
	2	2700 (186)		2336 (161)		1779 (123)		1347 (93)		1077 (74)		968 (67)		797 (55)		674 (46)	
SHU Ultra High Pressure T321 & T316L (See page 459)	0	500 (34)						250 (17)	4.5 (114)	180 (12)	7.0 (178)	190 (13)	9.5 (241)	110 (8)	11.5 (292)	100 (7)	12.0 (305)
	1	5000 (345)	4.5 (114)	-	-	-	-	2650 (182)	10.0 (254)	2500 (172)	11.0 (279)	1775 (122)	12.5 (318)	1450 (100)	13.0 (330)	1100 (76)	14.0 (356)
	2	6000 (414)						3600 (248)	10.0 (254)	3000 (207)	11.0 (279)	2600 (179)	12.5 (318)	2200 (152)	13.0 (330)	1675 (115)	14.0 (356)
	3	-						-	-	-	-	3000 (207)	14.0 (356)	-	-	-	-
SHV Vacuum / Formable Stay-Put Application T321, T316L (See page 460)	0	90 (6)		70 (5)		70 (5)											
	1	900 (62)		800 (55)		665 (46)											
SHE Extra Flexible Most Flexible T321, T316L, T304L (See page 461)	0	90 (6)		70 (5)		70 (5)		43 (3)		43 (3)		43 (3)		28 (2)		14 (1)	
	1	1800 (124)	3.7 (94)	1558 (107)	4.0 (102)	1186 (82)	4.4 (112)	898 (62)	6.4 (163)	718 (50)	7.1 (180)	645 (44)	7.9 (201)	531 (37)	8.7 (221)	449 (31)	10.3 (262)
	2	2700 (186)		2336 (161)		1779 (123)		1347 (93)		1077 (74)		968 (67)		797 (55)		674 (46)	
SHH High Pressure Helical High-Pressure T316L (See page 462)	1	4600 (317)		3800 (262)		2600 (179)		-		-		-		-		-	
	2	5800 (400)	5.0 (127)	4000 (276)	5.5 (140)	3700 (255)	5.7 (145)	-		-		-		-		-	
THT Smooth Core PTFE Metal Braided Hose (See page 472)	1	3200 (221)	1.5 (38)	2500 (172)	2.0 (51)	2000 (138)	3.0 (76)	1000 (69)	8.2 (208)	1000 (69)	12.0 (305)	-	-	-	-	-	-
THS Silicon Covered Smooth Core PTFE Metal Braided Hose (See page 473)	1	3250 (224)	1.5 (38)	2500 (172)	2.0 (51)	2000 (138)	3.0 (76)	1000 (69)	8.2 (208)	1000 (69)	12.0 (305)	-	-	-	-	-	-
THC Convolute Core PTFE Metal Braided Hose (See page 474)	1	-	-	-	-	1500 (103)	2.5 (64)	1100 (76)	3.0 (76)	1000 (69)	5.5 (140)	-	-	700 (48)	6.0 (152)	525 (36)	7.5 (191)

HAM-LET Hoses End Connections Selection

End Connection Type	End Connection Size	Metal Hoses - Series SHF / SHU / SHV / SHE / SHH I.D. inch (mm)							PTFE Hoses - Series THT / THS / THC I.D. inch (mm)							
		1/4 (6.35)	3/8 (9.53)	1/2 (12.70)	3/4 (19.05)	1 (25.40)	1 1/4 (31.75)	1 1/2 (38.10)	2 (50.80)	1/4 (6.35)	3/8 (9.53)	1/2 (12.70)	3/4 (19.05)	1 (25.40)	1 1/2 (38.10)	2 (50.80)
LET-LOK®	1/4"	○								○						
	3/8"	○	○								○					
	1/2"			○								○				
	3/4"				○							○				
	1"					○							○			
	1 1/4"						○							○		
	1 1/2"							○							○	
	2"								○							○
	6mm	○								○						
	8mm	○														
	10mm		○													
	12mm			○												
	18mm				○								○			
	25mm					○								○		
	38mm								○						○	
Tube Adapter (11/4-2 are preswaged)	1/4"	○								○						
	3/8"		○								○					
	1/2"			○								○				
	3/4"				○							○	○			
	1"					○						○	○			
	1 1/4"						○							○		
	1 1/2"							○							○	
	6mm	○														
	8mm	○														
	10mm		○													
	12mm			○												
	18mm				○								○			
	25mm					○								○		
	38mm								○						○	
	ONE-LOK®	1/4"	○													
3/8"		○	○													
1/2"				○												
6mm		○														
8mm		○														
10mm			○													
12mm				○												
UH Line (for vacuum only)	1/4"	○														
	3/8"	○	○													
	1/2"			○												
	3/4"				○											
	1"					○										
Male NPT	1/4"	○	○													
	3/8"		○	○												
	1/2"	○	○	○												
	3/4"				○								○			
	1"					○								○		
	1 1/4"						○									
	1 1/2"							○							○	
	2"									○						○

HAM-LET Hoses End Connections Selection (cont.)

End Connection Type	End Connection Size	Metal Hoses - Series SHF / SHU / SHV / SHE / SHH I.D. inch (mm)							PTFE Hoses - Series THT / THS / THC I.D. inch (mm)							
		1/4 (6.35)	3/8 (9.53)	1/2 (12.70)	3/4 (19.05)	1 (25.40)	1 1/4 (31.75)	1 1/2 (38.10)	2 (50.80)	1/4 (6.35)	3/8 (9.53)	1/2 (12.70)	3/4 (19.05)	1 (25.40)	1 1/2 (38.10)	2 (50.80)
Male BSPB	1/4"	○								○						
	3/8"		○								○					
	1/2"			○								○				
	3/4"				○								○			
	1"					○								○		
	1 1/4"						○									
	1 1/2"							○							○	
Female NPT	1/4"	○								○	○					
	3/8"		○								○					
	1/2"			○								○				
	3/4"				○								○			
	1"					○								○		
	1 1/2"							○							○	
	2"															○
Female BSPB	1/4"	○								○						
	3/8"		○								○					
	1/2"			○								○				
	3/4"				○								○			
	1"					○								○		
	1 1/2"							○							○	
	2"															○
Butt Weld adapter	1/4"	○								○						
	3/8"		○								○					
	1/2"			○								○				
	3/4"				○								○			
	1"					○								○		
	1 1/4"						○									
	1 1/2"							○								
Male Face Seal Swivel	1/4"	○														
	1/2"			○												
	3/4"				○											
	1"					○										
Female Face Seal Swivel	1/4"	○														
	3/8"		○													
	1/2"			○												
	3/4"				○											
Male JIC 37° Flare	1/4"	○														
	3/8"		○													
	1/2"			○												
	3/4"				○											
	1"					○										
	1 1/4"						○									
	1 1/2"							○								
Female JIC 37° Flare	1/4"	○														
	3/8"		○													
	1/2"			○												
	3/4"				○											

HAM-LET Metal Hoses

General

The HAM-LET Metal Hoses are top quality all stainless steel factory welded assemblies that are manufactured and tested to meet industry demands and regulation for chemical, process, Oil & Gas, Power generation, Pumps & Vacuum, instrumentation, gases and semiconductors manufacturing and machinery.

The HAM-LET Metal Hose assemblies are constructed from only best materials and components and by the most advanced corrugating and welding technologies for leak free durable performances.

HAM-LET Metal Hoses are the best solution for flexible connection of Gas & Liquid lines where vibrating, moving parts and installations involve high temperatures, chemicals and aggressive media, high pressures and full vacuum.

Features

- All stainless steel assembly
- LET-LOK®, ONE-LOK®, Face seal, UH Line end fittings among others
- ID sizes: 1/4" up to 2"
- Pressure rating: Vacuum to 6,000 psi (414 bar), 4 to 1 safety factor
- Working temperatures -425°F (-254°C) up to 1300°F (705°C)
- Hydroformed or spirally-welded corrugated inner hose
- Machine braided (braid is woven directly on inner hose)
- Maximum Working Pressure marked on metal tag as standard.
- Manufactured in accordance to
 - NAHAD - Corrugated Metal Hose Assembly specification guidelines
 - DIN ISO 10380:2013 (ISO 10380:2012 for designated items)- Pipework - Corrugated metal hoses and hose assemblies.

Metal Hoses Manufacturing Process

Corrugated Tube

A high quality stainless steel thin walled tube is specifically manufactured. As a second stage, corrugations are formed into the tube to make it flexible. Corrugations are formed into the tube hydraulically using a unique process called "Hydroforming" (rather than the commonly used mechanical method).

Hydroforming process evenly distributes stresses on the tube wall. This unique method maintains wall thickness, reduces concentrated residual stress, and minimizes work hardening, resulting in enhanced flexibility and prolong cycle life.

Hydroformed

Evenly distributed stresses

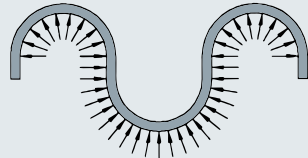

Mechanically Formed

Concentrated stresses

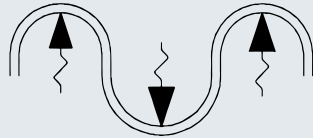

Hydroforming is a clean process, using water to form the hose, while most other processes require lubrication.

There are two corrugation profiles:



Annular Profile

Independent corrugations, straight and parallel



Helical Profile

One continuous corrugation that spirals around the hose

Braid

As a third (optional) stage, stainless steel wire is braided over the hose enabling the corrugated hose the ability to withstand higher pressures. Hoses may be single braided (one layer of braid) or double braided (two layers of braid) to achieve even greater working pressures.

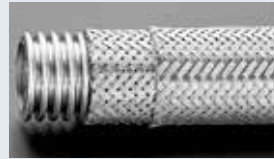

Braiding Superiority - A High Percentage Braid Coverage - highest percentage of braid coverage, yielding better cycle life and protection against damage to the hose.

Machine Braided - The braid is woven directly onto the hose, ensuring that the braid fits tightly against the hose, preventing potential hose deformation or squirm. Machine braided hose also offers repeatable performance and longer cycle life.

Assembly

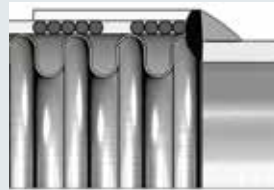

Combining top quality hose with top quality fittings together with a specialized welding, brazing, joining, fabrication procedures, and severe testing assures compatibility, integrity and serviceability of metal hose

assemblies in even the most extreme applications and demanding industries.

Standard assembly process consists of:

- Cutting the hose and braid through a hose corrugation valley.
 - Installing a braid collar over each end of the hose.
 - Trimming of any excess braid.
 - "Cap" welding the hose, braid, and braid collar together.
 - Cleaning the cap weld surface.
 - Placement and alignment of a fitting on the cap weld.
 - "Attachment" welding the fitting to the cap weld.
- The assembled hose is tested, cleaned, marked and packed as required.

Metal Hose Selecting Considerations:

When selecting a Flexible Metal Hose, consider the following 5 variables:

1. Temperature

As the media or ambient temperature increases, the hose working pressure decreases. With your selected hose construction materials, go to "Working Pressure De-Rating Factor" table and match the alloy of the hose and braid with the highest temperature to which they will be exposed (either internally or externally) to obtain the proper de-rating factors. Then multiply the hose maximum working pressure by the most limiting temperature de-rating factor, Maximum Working Pressures marked on metal tag as standard.

2. Dynamic Pressure

Pulsating, surge or shock pressures, like those encountered by quick opening or closing valves, can inflict severe damage on a hose. If your application entails pulsating pressures, the working pressure should be de-rated by 1/2. If your application entails shock pressures, de-rate the stated working pressure to 1/6 of its value.

Example : 1/4" hose - T316L stainless steel hose and T304 stainless steel braid at 500°F with the shock pressures:
 Catalog Maximum Working Pressure = 1800 psi
 Temperature De-rating Factor at 500°F = 0.86
 Pressure De-rating Factor = 1/6 Maximum Application Working
 Actual allowable working pressure = 1800 PSI x 0.86 x 1/6 = 258 psi

3. Flexibility

Verify that the minimum bend radius of the hose is less than the bend radius required.
 Larger installation radius reduces fatigue on the hose for a longer assembly life.

4. Chemical Compatibility

The material that you choose for the hose and braid must be compatible with the media that will flow through the hose, as well as the environment in which the hose is installed. When determining chemical compatibility, be sure that you know the temperature and concentration of the chemical or chemicals. Although there are many resources to confirm chemical compatibility, two of the industry standards that you may find useful are the National Association of Corrosion Engineers (NACE) and the Compass Corrosion Guides.

5. Accessories

Optional accessories available include spring guards, protective covers, insulating covers and protective armor.

Cleaning & Packing

The hydroforming hose manufacturing process yields a very clean product.

Clean and Degrease to CGA G-4.1 "Oxygen Clean" is available.

Ultrasonic Cleaning for Pharmaceutical application is available. Each hose is packed in a plastic bag, end connections are capped.

Testing

All HAM-LET hose assemblies are 100% Helium leak tested up to 1x10⁻⁶ Std. CC/Sec.

Helium leak testing up to 1x10⁻⁹ Std. CC/Sec is available.

Other test such as Hydrostatic testing, Nitrogen/Helium bubble test are available.

*Helium leak test is available to hoses up to 100' (30m)

Working pressure de-rating factor:

Temp. in		304	304L	316	316L	321	C276
Degrees F	Degrees C						
70	20	1.00	1.00	1.00	1.00	1.00	1.00
100	40	1.00	1.00	1.00	1.00	1.00	1.00
200	95	1.00	1.00	1.00	1.00	1.00	1.00
300	150	1.00	1.00	1.00	1.00	1.00	1.00
400	205	0.94	0.93	0.97	0.93	1.00	1.00
500	260	0.88	0.86	0.90	0.86	0.96	0.99
600	315	0.82	0.81	0.85	0.81	0.91	0.93
650	345	0.81	0.79	0.84	0.79	0.89	0.90
700	370	0.80	0.77	0.82	0.77	0.87	0.88
750	400	0.78	0.75	0.81	0.75	0.86	0.86
800	430	0.76	0.74	0.80	0.74	0.84	0.84
850	455	0.75	0.72	0.79	0.72	0.84	0.83
900	480	0.73	0.71	0.78	0.71	0.83	0.82
950	510	0.72	0.69	0.77	0.69	0.81	0.81
1000	540	0.69	0.67	0.77	0.67	0.81	0.80
1050	565	0.61	0.65	0.73	0.65	0.70	0.68
1100	595	0.49	0.62	0.62	0.61	0.55	0.55
1150	620	0.39	0.53	0.49	0.52	0.41	0.47
1200	650	0.30	0.38	0.37	0.38	0.32	0.36
1250	675	0.24	0.28	0.28	0.28	0.25	0.29
1300	705		0.21	0.21	0.21		

General

The SHF - General Use hose series is the basic hose for industrial applications of gas & liquid lines with high temperatures, corrosive media and harsh environment.

Features

- Braided, double braided or unbraided corrugated tube assembly
- Core tube is made of 316L stainless steel, 321 stainless steel core tube is available.
- Braid is made of 304 stainless steel, 316 stainless steel braid is available.
- Annular Hydroformed corrugation
- Tube ID from ¼" to 2"
- Max. pressure 2700psi (186bar)
- Min. static bend radius for braided hose 1.0inch (25mm)
- Min. dynamic bend radius for braided hose 4.5inch (114mm)
- Full range of end connections

SHF Series - General Use

Inside Diameter		Number of Braids	Outside Diameter		Static Minimum Bend Radius		Dynamic Minimum Bend Radius		Maximum Working Pressure		Burst Pressure		Weight Per Foot	Weight Per Meter
(inch)	(mm)		(inch)	(mm)	(inch)	(mm)	(inch)	(mm)	(psi)	(bar)	(psi)	(bar)	(lbs)	(kg)
1/4	6.35	0	0.41	10.4	1.0	25	4.5	114	90	6	n/a	n/a	0.04	0.06
		1	0.47	11.9					1800	124	7233	499	0.11	0.16
		2	0.53	13.5					2700	186	9100	627	0.18	0.27
3/8	9.53	0	0.65	16.5	1.2	30	5.0	127	70	5	n/a	n/a	0.10	0.15
		1	0.71	18.0					1558	107	6230	430	0.20	0.30
		2	0.77	19.6					2336	161	9345	644	0.30	0.45
1/2	12.70	0	0.77	19.6	1.5	38	5.5	140	70	5	n/a	n/a	0.11	0.16
		1	0.83	21.1					1186	82	4743	327	0.22	0.33
		2	0.89	22.6					1779	123	7115	491	0.33	0.49
5/8	15.88	0	0.96	24.4	1.8	46	7.0	178	57	4	n/a	n/a	0.17	0.25
		1	1.02	25.9					1205	83	4820	332	0.33	0.49
		2	1.08	27.4					1808	125	7230	498	0.49	0.73
3/4	19.05	0	1.16	29.5	2.1	53	8.0	203	43	3	n/a	n/a	0.19	0.28
		1	1.22	31.0					898	62	3591	248	0.37	0.55
		2	1.28	32.5					1347	93	5387	371	0.55	0.82
1	25.40	0	1.47	37.3	2.7	69	9.0	229	43	3	n/a	n/a	0.26	0.39
		1	1.53	38.9					718	50	2872	198	0.50	0.74
		2	1.59	40.4					1077	74	4308	297	0.74	1.10
1 1/4	31.75	0	1.75	44.5	3.1	79	10.0	254	43	3	n/a	n/a	0.29	0.43
		1	1.83	46.5					645	44	2581	178	0.61	0.91
		2	1.91	48.5					968	67	3872	267	0.93	1.38
1 1/2	38.10	0	2.08	52.8	3.9	99	11.0	279	28	2	n/a	n/a	0.47	0.70
		1	2.16	54.9					531	37	2125	147	0.85	1.26
		2	2.24	56.9					797	55	3188	220	1.23	1.83
2	50.80	0	2.61	66.3	5.1	130	13.0	330	14	1	n/a	n/a	0.59	0.88
		1	2.69	68.3					449	31	1797	124	1.11	1.65
		2	2.77	70.4					674	46	2696	186	1.63	2.43



Materials Of Construction

Part	Material
Tube	SS 316L / SS 321
Braid	SS 304 / SS 316
End Connections	SS 316L

General

The SHU - Ultra high pressure hose series is hydroformed annular, heavy-wall corrugated metal hose, specifically designed for ULTRA-high-pressure applications.

The SHU hoses offer superior flexibility and are made from heavy-wall 321 stainless steel.

Features

- Braided, double braided or unbraided corrugated tube assembly
- Core tube is made of 321 stainless steel, 316L stainless steel core tube is available.
- Braid is made of 304 stainless steel, 316 stainless steel braid is available.
- Annular Hydroformed corrugation
- Tube ID 1/4", 3/4" up to 2"
- Max. pressure 6000psi (414bar), 4 to 1 safety rate factor
- Min. static bend radius for braided hose 0.9 inch (23mm)
- Min. dynamic bend radius for braided hose 4.5inch (114mm)
- Full range of end connections

SHU Series - Ultra High Pressure

Inside Diameter		Number of Braids	Outside Diameter		Static Minimum Bend Radius		Dynamic Minimum Bend Radius		Maximum Working Pressure		Burst Pressure		Weight Per Foot	Weight Per Meter
(inch)	(mm)		(inch)	(mm)	(inch)	(mm)	(inch)	(mm)	(psi)	(bar)	(psi)	(bar)	(lbs)	(kg)
1/4	6.35	0	0.43	10.9	0.5	13	4.5	114	500	34	n/a	n/a	0.15	0.22
		1	0.56	14.1	1.5	38			5000	345	20000	1379	0.32	0.48
		2	0.68	17.3	1.5	38			6000	414	24000	1655	0.49	0.73
3/4	19.05	0	1.15	29.2	2.5	64	4.5	114	250	17	n/a	n/a	0.63	0.94
		1	1.28	32.5	4.0	102	10.0	254	2650	183	10669	736	1.09	1.62
		2	1.40	35.6	4.0	102	10.0	254	3600	248	14521	1001	1.58	2.35
1	25.40	0	1.45	36.8	3.25	83	7.0	178	180	12	n/a	n/a	0.84	1.25
		1	1.57	39.9	5.0	127	11.0	279	2500	172	10000	689	1.53	2.28
		2	1.70	43.2	5.0	127	11.0	279	3000	207	12083	833	2.25	3.35
1 1/4	31.75	0	1.75	44.5	5.0	127	9.5	241	190	13	n/a	n/a	1.32	1.96
		1	1.88	47.8	6.5	165	12.5	318	1775	122	7119	491	2.09	3.11
		2	2.00	50.8	6.5	165	12.5	318	2600	179	10400	717	2.88	4.29
		3	2.13	54.1	7.0	178	14.0	356	3000	207	12082	833	3.71	5.52
1 1/2	38.10	0	2.11	53.6	6.0	152	11.5	292	110	8	n/a	n/a	1.75	2.60
		1	2.23	56.6	7.5	191	13.0	330	1450	100	5800	400	2.64	3.93
		2	2.36	59.9	7.5	191	13.0	330	2200	152	8892	613	3.57	5.31
2	50.80	0	2.57	65.3	7.5	191	12.0	305	100	7	n/a	n/a	2.04	3.04
		1	2.70	68.6	9.0	229	14.0	356	1100	76	4415	304	3.23	4.81
		2	2.82	71.6	9.0	229	14.0	356	1675	115	6710	463	4.45	6.62



Materials Of Construction

Part	Material
Tube	SS 321 / SS 316L
Braid	SS 321
End Connections	SS 316L

General

The SHV - Vacuum /Formable hoses series are hand formable tubes that keep their formation. These hoses are designed to bend and stay in one position, providing a stress-free connection between piping systems .
SHV hose can be compressed or stretched to fit into an exact space in the system

Features

- Braided or unbraided corrugated tube assembly.
- Core tube is made of 321 stainless steel, 316L stainless steel core tube is available.
- Braid is made of 304 stainless steel
- Annular Hydroformed corrugation
- Tube ID 1/4", 3/8", 1/2"
- Max. pressure 900psi (62bar)
- Min. static bend radius for braided hose 1.0inch (25mm)
- Full range of end connections

SHV Series - Vacuum/Formable

Inside Diameter		Number of Braids	Outside Diameter		Static Minimum Bend Radius		Dynamic Minimum Bend Radius		Maximum Working Pressure		Burst Pressure		Weight Per Foot (lbs)	Weight Per Meter (kg)
(inch)	(mm)		(inch)	(mm)	(inch)	(mm)	(inch)	(mm)	(psi)	(bar)	(psi)	(bar)		
1/4	6.35	0	0.41	10.4	1.0	25	n/a	n/a	90	6	n/a	n/a	0.04	0.06
		1	0.47	11.9					900	62	3600	248	0.11	0.16
3/8	9.53	0	0.65	16.5	1.2	30	n/a	n/a	70	5	n/a	n/a	0.10	0.15
		1	0.71	18.0					800	55	3200	221	0.17	0.25
1/2	12.70	0	0.77	19.6	1.5	38	n/a	n/a	70	5	n/a	n/a	0.11	0.16
		1	0.83	21.1					665	46	2660	183	0.19	0.28



Materials of Construction

Part	Material
Tube	SS 321 / SS 316L
Braid	SS 304
End Connections	SS 316L



Formable hoses

General

The SHE - Extra flexible hose series combines the same pressure rating performances as the SHF - general use series with improved flexibility for smaller minimal static and dynamic bend radiuses.

The extra flexibility is provided by denser corrugations while maintaining the same production process and material specifications.

Features

- Braided, double braided or unbraided corrugated tube assembly
- Core tube is made of 316L stainless steel, 321 stainless steel core tube is available.
- Braid is made of 304 stainless steel, 316 stainless steel braid is available.
- Annular Hydroformed corrugation
- Tube ID from 1/4" to 2"
- Max. pressure 2700psi (186bar)
- Min. static bend radius for braided hose 0.9inch (23mm)
- Min. dynamic bend radius for braided hose 3.7inch (94mm)
- Full range of end connections

SHE Series - Extra Flexible

Inside Diameter		Number of Braids	Outside Diameter		Static Minimum Bend Radius		Dynamic Minimum Bend Radius		Maximum Working Pressure		Burst Pressure		Weight Per Foot (lbs)	Weight Per Meter (kg)
(inch)	(mm)		(inch)	(mm)	(inch)	(mm)	(inch)	(mm)	(psi)	(bar)	(psi)	(bar)		
1/4	6.35	0	0.42	10.7	0.9	23	3.7	94	90	6	n/a	n/a	0.07	0.10
		1	0.48	12.2					1800	124	7233	499	0.14	0.21
		2	0.54	13.7					2700	186	9100	627	0.20	0.30
3/8	9.53	0	0.65	16.5	1.0	25	4.0	102	70	5	n/a	n/a	0.15	0.22
		1	0.71	18.0					1558	107	6230	430	0.25	0.37
		2	0.77	19.6					2336	161	9345	644	0.36	0.54
1/2	12.70	0	0.77	19.6	1.2	30	4.4	112	70	5	n/a	n/a	0.18	0.27
		1	0.83	21.1					1186	82	4743	327	0.32	0.48
		2	0.89	22.6					1779	123	7115	491	0.47	0.70
5/8	15.88	0	0.96	24.4	1.4	36	5.6	142	57	4	n/a	n/a	0.19	0.28
		1	1.02	25.9					1205	83	4820	332	0.37	0.55
		2	1.08	27.4					1808	125	7230	498	0.54	0.80
3/4	19.05	0	1.16	29.5	1.7	43	6.4	163	43	3	n/a	n/a	0.31	0.46
		1	1.22	31.0					898	62	3591	248	0.53	0.79
		2	1.28	32.5					1347	93	5387	371	0.74	1.10
1	25.40	0	1.47	37.3	2.1	53	7.1	180	43	3	n/a	n/a	0.41	0.61
		1	1.53	38.9					718	50	2872	198	0.76	1.13
		2	1.63	41.4					1077	74	4308	297	1.11	1.65
1 1/4	31.75	0	1.75	44.5	2.5	64	7.9	201	43	3	n/a	n/a	0.63	0.94
		1	1.83	46.5					645	44	2581	178	1.00	1.49
		2	1.91	48.5					968	67	3872	267	1.37	2.04
1 1/2	38.10	0	2.08	52.8	3.1	79	8.7	221	28	2	n/a	n/a	0.70	1.04
		1	2.16	54.9					531	37	2125	147	1.16	1.73
		2	2.24	56.9					797	55	3188	220	1.63	2.43
2	50.80	0	2.61	66.3	4	102	10.3	262	14	1	n/a	n/a	0.88	1.31
		1	2.69	68.3					449	31	1797	124	1.44	2.14
		2	2.77	70.4					674	46	2696	186	1.99	2.96



Materials of Construction

Part	Material
Tube	SS 316L / SS 321
Braid	SS 304 / SS 316
End Connections	SS 316L

General

The SHH - High pressure hose series are spirally-welded corrugated all stainless steel metal hose.

The SHH hoses are specially designed to maintain extreme pressure and flexibility the spiral corrugation inner tube is self-draining and generates minimal in-line turbulence.

Features

- Braided corrugated tube assembly.
- Core tube is made of 316L stainless steel, 321 stainless steel core tube is available.
- Braid is made of 304 stainless steel, 316 stainless steel braid is available
- Spiral double-walled welded corrugation
- Tube ID 1/4", 3/8", 1/2"
- Max. pressure 5800psi (400bar)
- Min. static bend radius for braided hose 1.1inch (28mm)
- Min. dynamic bend radius for braided hose 5.0inch (127mm)
- Full range of end connections

SHH Series - High Pressure

Inside Diameter		Number of Braids	Outside Diameter		Static Minimum Bend Radius		Dynamic Minimum Bend Radius		Maximum Working Pressure		Burst Pressure		Weight Per Foot (lbs)	Weight Per Meter (kg)
(inch)	(mm)		(inch)	(mm)	(inch)	(mm)	(inch)	(mm)	(psi)	(bar)	(psi)	(bar)		
1/4	6.35	1	0.52	13.2	1.1	28	5.0	127	4600	317	18400	1269	0.21	0.31
		2	0.62	15.7					5800	400	23200	1600	0.32	0.48
3/8	9.53	1	0.70	17.8	1.4	36	5.5	140	3800	262	15200	1048	0.36	0.54
		2	0.82	20.8					4000	276	16000	1103	0.57	0.85
1/2	12.70	1	0.82	20.8	1.6	41	5.7	145	2600	179	10400	717	0.43	0.64
		2	0.94	23.9					3700	255	14800	1020	0.69	1.03



Materials Of Construction

Part	Material
Tube	SS 316L
Braid	SS 304
End Connections	SS 316L

Selecting & Installing Metal Hose Assemblies

When Metal Hose Is A Proper Solution

1. Temperature Extremes

Metal Hose is the best solution for extreme hot and cold media or surrounding temperatures.

2. Chemical Compatibility

Chemicals and aggressive media or corrosive environments are often better serviced by stainless metal hose.

3. Permeation Concerns

Permeation prevention of media into the surrounding atmosphere is best assured by using metal hose.

4. Potential for Catastrophic Failure

Potentially catastrophic failure effect of hose may be minimized by using metal hose that tends to develop smaller holes or cracks when failing than other hose types.

5. Fire Safety

Maintaining integrity up to 1300°F (705°C) is provided by metal hoses.

6. Achieving Full Vacuum

Maintaining shape under full vacuum is better assured by metal hoses.

7. Flexibility in Fitting Configuration

Virtually any type of fitting can be assembled with a metal hose to perfectly meet most tubing and fitting systems.

Hose Assembly

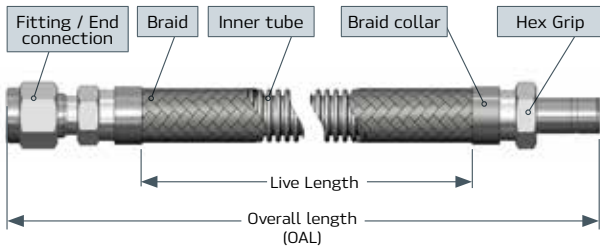

Thread Allowance

When calculating the overall length (OAL) of a hose assembly that has a pipe thread as one or both end connection(s), consideration must be given to thread engagement.

Example: using the chart below, a hose assembly with a 1" male pipe on one end would have 0.66" added to the OAL to compensate for the length of thread that will be engaged during installation.

Nominal Pipe Size inch	1/4	3/8	1/2	3/4	1	1 1/4	1 1/2	2
Thread Allowance inch (mm) -Dim "A"	0.40 (10)	0.41 (10)	0.53 (13)	0.55 (14)	0.66 (17)	0.68 (17)	0.68 (17)	0.70 (18)

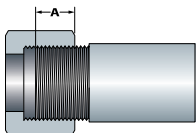

Length Considerations

To calculate the proper length of a hose assembly, you need to:

- Verify that the installation is properly designed (see Do's & Don'ts herein)
 - Do not torque the hose
 - Do not over-bend the hose
 - Do not compress the hose
- Calculate the live length of the assembly - The live length of the assembly is the amount of active (flexible) hose in an assembly; that is, the hose between the braid collars (see formulas to help calculate live length for a variety of common hose installations herein)
- Calculate the overall length of the assembly - Overall length is equal to the live length plus the lengths of the braid collars and fittings. When adding fitting lengths, be aware that the points from which measurements should be taken vary for different fitting types. When calculating overall length for assemblies with threaded fittings, remember to account for the length of thread that is lost by threading into the mating connection (refer to Thread Allowance chart herein).

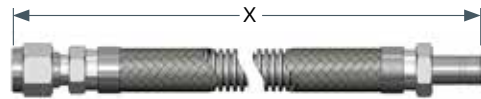

Compression fittings are measured to the end of the fitting

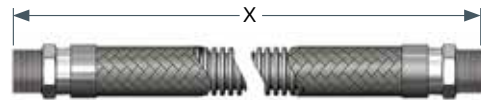

Threaded fittings are measured to the end of the fitting



JIC/SAE-type fittings are measured from the seat of the fitting

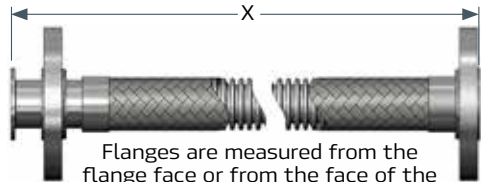

Flanges are measured from the flange face or from the face of the stub end if one is used

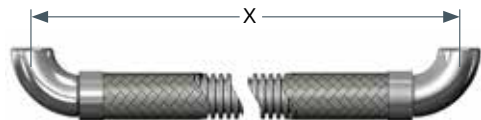

Elbows and other fittings with a radius are measured from the centerline of the fitting

Selecting & Installing Metal Hose Assemblies

Live Length Calculations

For the following formulas:

L	Live length of hose (inches/mm)
T	Travel (inches/mm)
S	Hose outside diameter (see product data pages herein)
R	Bend radius, measured to hose center line

Verify that the installed radius is greater than the stated Minimum Bend Radius for the hose at the required working pressure. Verify that the centerline of the hose remains in the same plane during cycling to prevent twisting the assembly.

Constant Radius Traveling Loop (A-Loop)

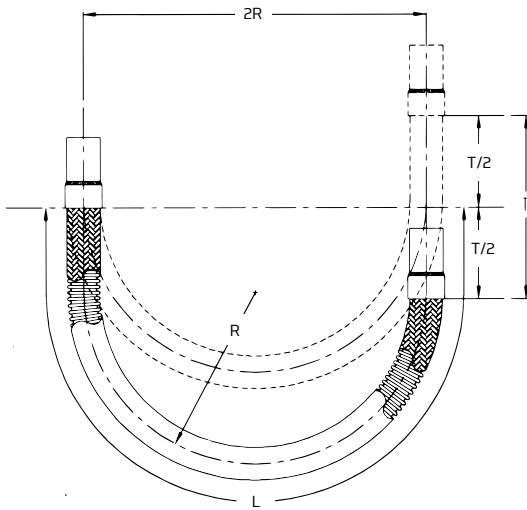

Formula: $L = 4R + 1/2T$

Variable Radius Traveling Loop (B-loop)

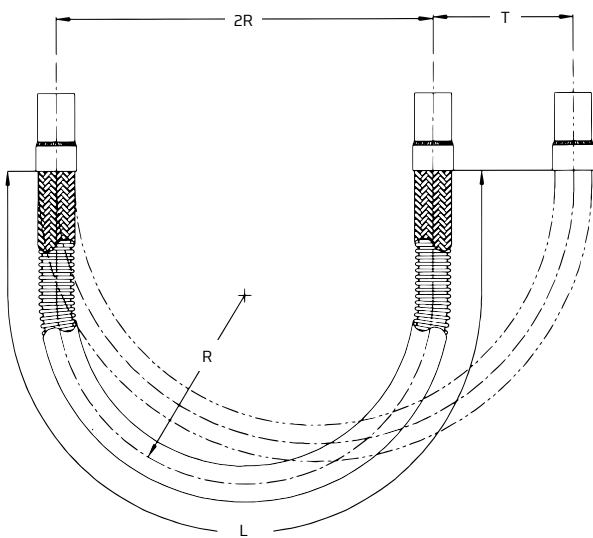

Formula: $L = 4R + 1.57T$

Lateral Offset

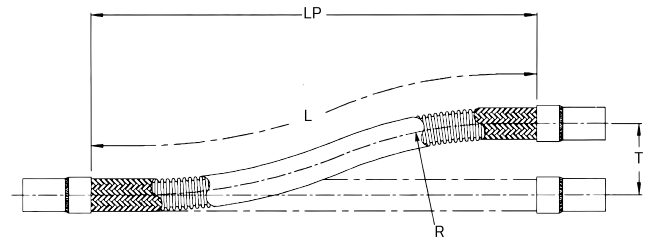

Formula: $L = \sqrt{20R \times T}$, $L_p = \sqrt{L^2 - T^2}$

Note 1: When the offset motion occurs on both sides of the hose centerline, use total travel in the formula

Note 2: The offset distance "T" for constant flexing should never exceed 25% of the centerline bend radius

Angular Deflection

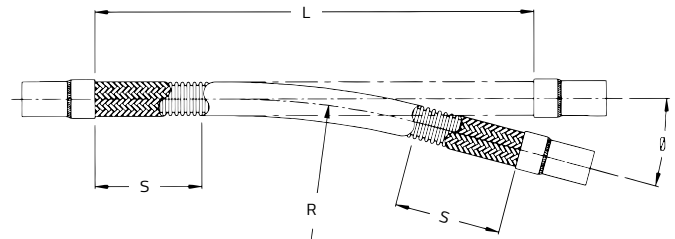

Formula: $L = 2S + (\theta/57.3)R$

Vertical Loop With Movement In Two Directions (combination loop)

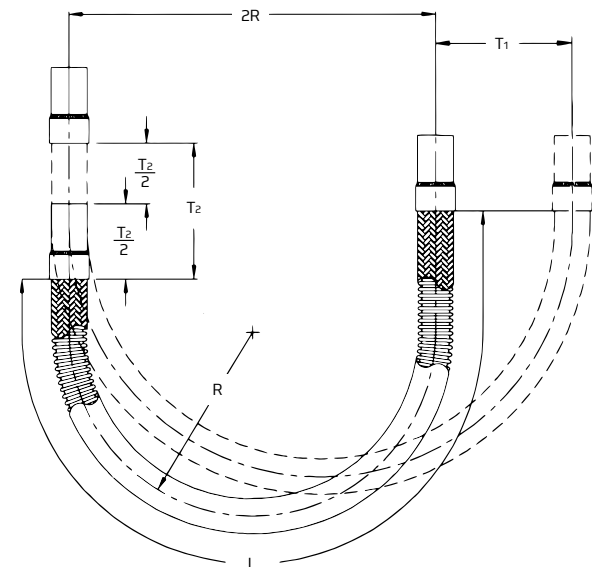

Formula: $L = 4R + 1.57T_1 + (T_2/2)$

Selecting & Installing Metal Hose Assemblies

Media Flow Velocity

When gas or liquid being conveyed in a corrugated metal hose exceeds certain limits, resonant vibration can occur. Resonance may cause a very rapid failure of the assembly. In applications where product velocities exceed the limits shown in the chart below, a revision of the assembly design might include:

1. Addition of an interlocked metal hose liner
2. An increase in the corrugated hose I.D.
3. A combination of the above

Velocity in Metal Hose				
Installation Configuration	Maximum Product Velocity Feet/Second (Meter/Second)			
	Unbraided		Braided	
	Dry Gas	Liquid	Dry Gas	Liquid
Straight Run	100 (30)	50 (15)	150 (46)	75 (23)
45 Degree Bend	75 (23)	40 (12)	115 (35)	60 (18)
90 Degree Bend	50 (15)	25 (8)	75 (23)	40 (12)
180 Degree Bend	25 (8)	12 (4)	38 (12)	19 (6)

Pressure Drop

Pressure drop in a piping system is often a concern for the designer. Compared to rigid pipe, there is always a greater pressure drop in corrugated metal hose. The following graphs are offered as aids in estimating pressure drop in corrugated hose conveying water and air. The values derived are approximate and apply only to straight-line installations. Bends and fittings can increase the pressure drop.

Pressure Drop Graph For Water

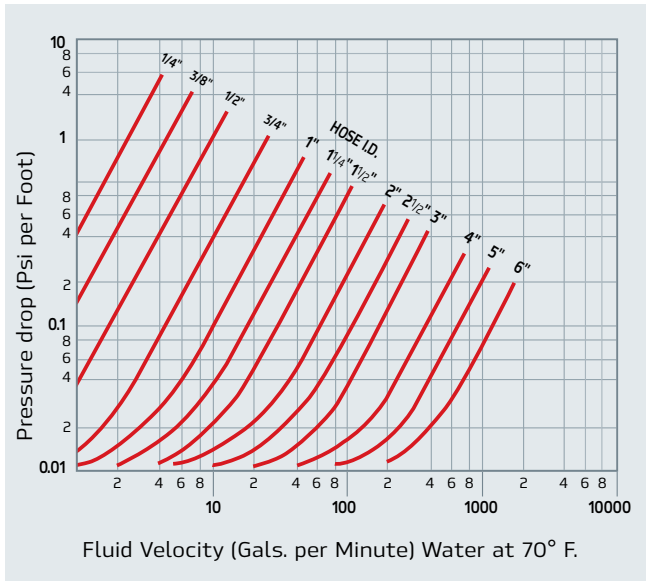

Pressure Drop Graph For Air

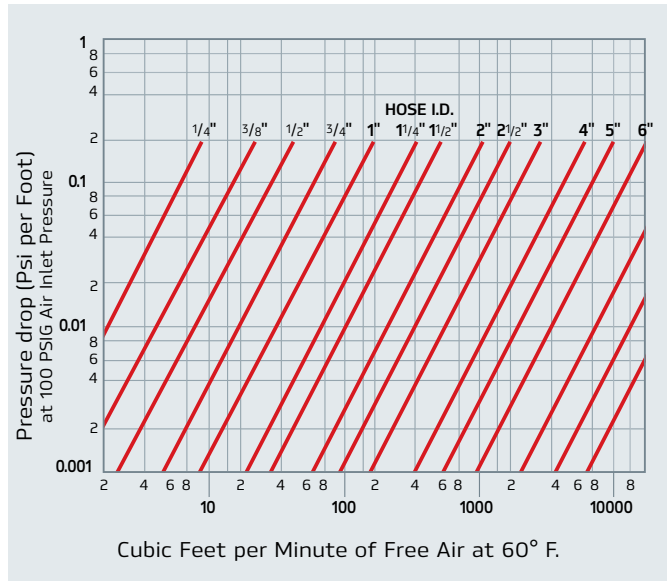

Selecting & Installing Metal Hose Assemblies

Vibration

The following graph is a representative guideline for estimation purposes only.

For any questions, or if your application is near the "Consult Factory" region, please contact your HAM-LET local representative.

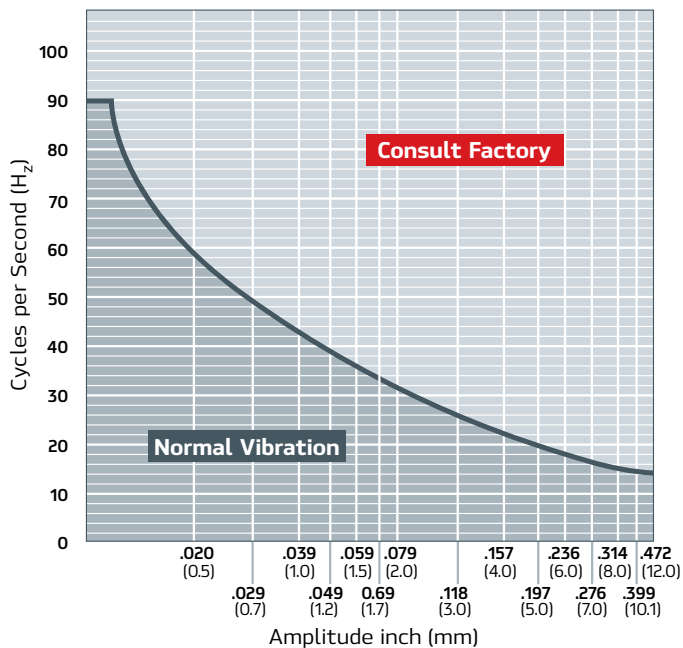

When installing a hose assembly in a vibration application, make sure to install it so the axis of the hose is perpendicular to the direction of the vibration.

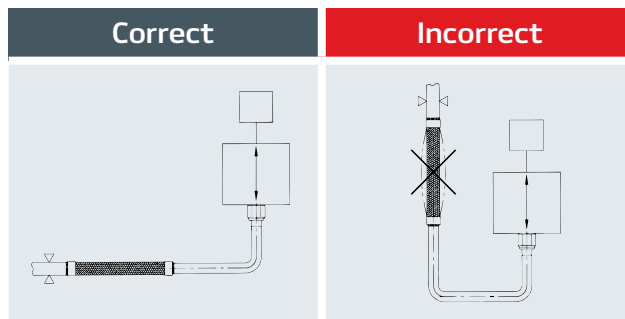



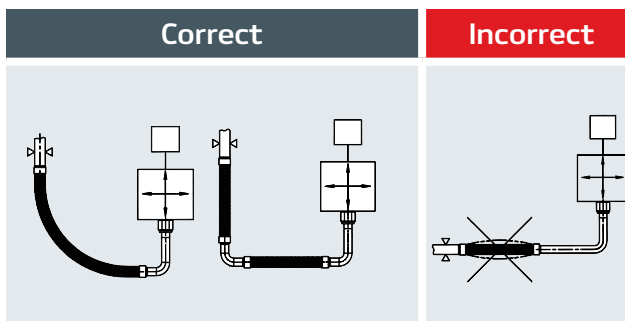

If there is vibration in more than one direction, either install a longer hose bent at 90° or install a "Dog Leg" assembly.

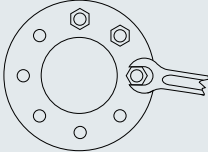
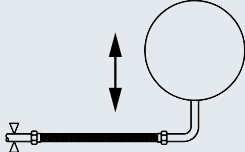
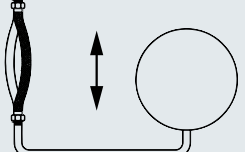
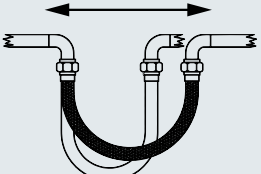

Selecting & Installing Metal Hose Assemblies

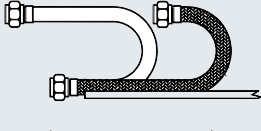
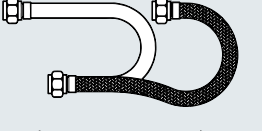
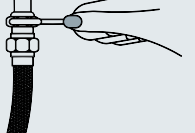
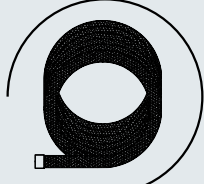
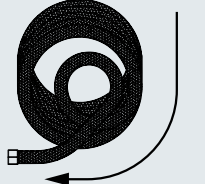
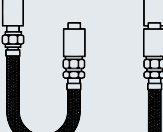
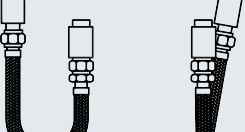
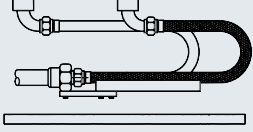
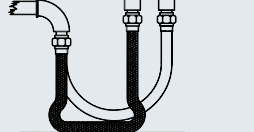
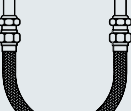
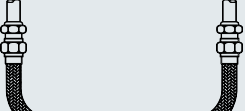
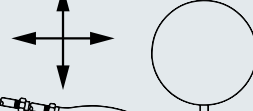
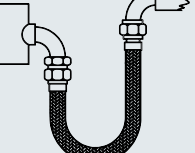
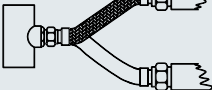
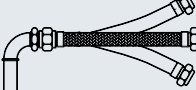
Installation Do's & Don'ts

Do's	Don'ts	Do's	Don'ts
			
			
			
			
			
			

Metal Hoses - Ordering Information

OPTIONAL

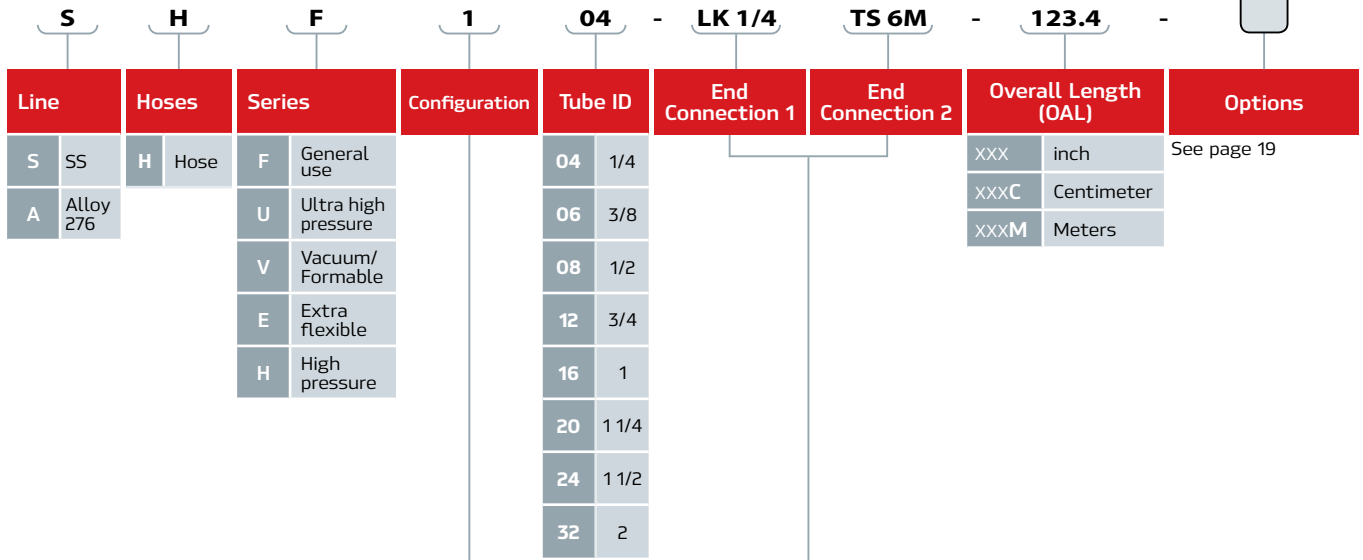

Line		Hoses		Series		Configuration	Tube ID		End Connection 1	End Connection 2	Overall Length (OAL)		Options
S	SS	H	Hose	F	General use	1	04	1/4	LK 1/4	TS 6M	XXX	inch	See page 19
A	Alloy 276			U	Ultra high pressure		06	3/8			XXXC	Centimeter	
				V	Vacuum/Formable		08	1/2			XXXM	Meters	

Configuration

Series	Configuration	Tube Material	Braid Material	# of braids
F	0	316L	-	0
	1	316L	304	1
	2	316L	304	2
	3	321	-	0
	4	321	304	1
	5	321	304	2
	6	316L	316	1
	7	316L	316	2
	8	321	316	1
9	321	316	2	
U	0	321	-	0
	1	321	321	1
	2	321	321	2
	3	316L	-	0
	4	316L	321	1
5	316L	321	2	
V	0	321	-	0
	1	321	304	1
	2	316L	-	0
	3	316L	304	1
E	0	316L	-	0
	1	316L	304	1
	2	316L	304	2
	3	321	-	0
	4	321	304	1
	5	321	304	2
	6	316L	316	1
	7	316L	316	2
	8	321	316	1
9	321	316	2	
H	0	316	-	0
	1	316	304	1
	2	316	304	2

End Type		End Size
LK	LET-LOK®	inch
TS	Tube Adapter	1/4, 3/8, 1/2, 3/4, 1, 1 1/4, 1 1/2
TP	Tube Adapter Preswaged	2
GF	Face Seal Female Swivel	mm
GM	Face Seal Male Swivel	6M, 8M, 10M, 12M, 18M, 25M, 38M
FP	Female Pipe NPT	
MP	Male Pipe NPT	
FG	Female BSP-P	
MG	Male BSP-P	
BW	Butt Weld Adapter	
HL	ONE-LOK®	
UH	UH-Line (Vacuum only)	
FF	Female Flare 37°	
MF	Male Flare 37°	

Warning!

The system designer and user have the sole responsibility for selecting products suitable for their special application requirements, ensuring their safe and trouble-free installation, operation, and maintenance. Application details, material compatibility and product ratings should all be considered for each selected product. Improper selection, installation or use of products can cause property damage or personal injury.

Metal Hoses - Options

Test		Cleaning		Internal Lamina		Outer Cover		Special Type		Tagging			
H	Helium Leak Test 1x10 ⁻⁹ Std. CC/Sec	O	Oxygen Cleaning	L	Liner	G	Spring Guard	E	EN 10380 Certified	T	Paper Tag	None	On One End
						R	Protective Cover			M	Metal Tag ⁽¹⁾	B	Both Ends
Y	Hydraulic Test					J	Insulating Jacket			P	Plastic Tag		
						A	Armor						
						N	Interlock bend restrictor						

(1) One end metal tag with MWP marking - is supply as standard (no need to mark this option to have this tag)



Spring Guard

A mechanical guard can be installed with the hose assembly. This type of guard consists of a metal spring that is attached behind the fitting.



Protective Cover

For lighter protection of the corrugated hose and braid, plastic scuff guards can be installed with hose.



Insulating Jacket

High temperature insulation of the hose exterior is available by adding an insulated protective jacket. The jacket consists of braided fiberglass insulation, covered and impregnated with silicone rubber that is then installed over the corrugated hose and sealed. The Insulation jacket can also be used to prevent ambient heat from being conveyed to the media or to reduce media heat loss.



Tagging

Customer or system information can be marked on hose assemblies using cardboard, plastic, and metal tags or permanently engraved onto braid collars. Tags and markings can be applied on single or both ends of assemblies.



Certifications

Materials, Standard Conformance and testing certificates are available. Other customer specific certificates are available upon request.

HAM-LET PTFE Hoses

General

PTFE stainless steel braided hose is an ideal solution for permanent or temporary connections of gases or liquid line. It makes fabrication easier, and it facilitates connect/disconnect and cleaning. Variable length, high flexibility, high pressures and broad chemical compatibility are among the features that make this hose the preferred solution for many applications.

HAM-LET PTFE hoses are available in smooth, convoluted or conductive carbon lined core with stainless-steel braid or silicon covered stainless-steel braided.

Testing & Packing

All Hoses are Hydrostatically tested at 1000 psi (69 bar) or maximum working pressure.

All Hoses packed individually in a plastic bag, end connections are capped.

Features

- PTFE core with all stainless steel braid and connections
- Non-contaminating, Non-absorbent, will not impart taste or odor
- Non-aging & non-stick surface
- Easy to clean, drain easily
- True I.D., Low friction
- LET-LOK®, ONE-LOK®, Male & Female NPT, Mini Sanitary Flange.
- ID Sizes: 1/4" up to 2".
- Max. pressure 3250 psi (224 bar), safety factor 1 to 4.
- Working temperature: -100° ~ +450° F (-73° ~ + 232°C)
- Pack and Validated for high purity service:
 1. Approved U.S. Pharmacopoeia Class VI
 2. Approved Food and Drug Administration (FDA) 21CFR177.1550
 3. Exceeds 3A Sanitary Standards
 4. U.S.D.A. Approved

Chemical Compatibility:

PTFE has one of the highest levels of chemical compatibility. Following is the list of materials that require some level of consideration:

The following materials are not recommended for use with PTFE hosing:

- Elemental Sodium
- Elemental Potassium
- Elemental Lithium

The materials listed below are only questionable if conveyed in conjunction with high temperature and pressure and/or a combination thereof:

- Fluorine (F2)
- Chlorine Tri-Fluoride (ClF3)
- Borane (B2H6) (Only at 400°F to 500°F)
- Iodine Pentafluoride
- Oxygen Difluoride
- Chlorine Difluoride
- 80% and over Sodium Hydroxide
- Bromine (B2H6) - only at 400°F to 500°F
- Aluminum Chloride (at elevated temps)
- Ammonia (NH3)
- Aluminum (R-NH2) - at elevated Temperature
- Imines (R-NH)
- 70% Nitric Acid

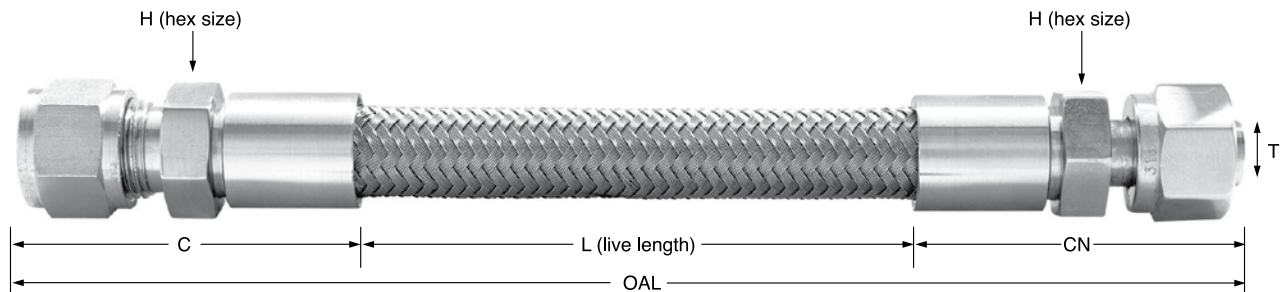

End Connector Dimensions

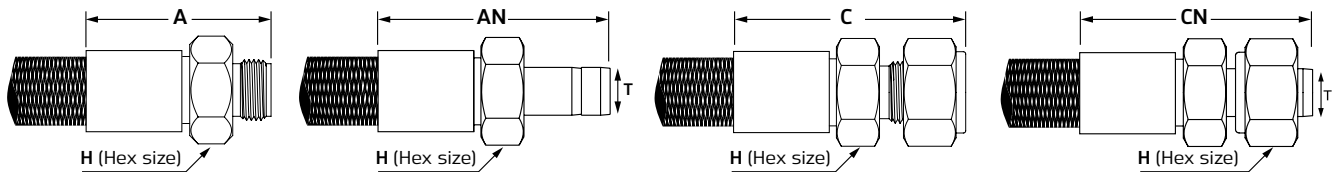

Hose Size	Minimum Flow Diameter	T Diameter	A Length	An Length	C Length	Cn Length	H Hex Size
1/4	0.190	1/4	1.48	1.70	1.73	1.70	0.562
3/8	0.280	3/8	1.78	2.00	2.08	2.00	0.687
1/2	0.375	1/2	2.07	2.53	2.48	2.53	0.875
3/4	0.630	3/4	2.50	3.04	2.81	3.04	1.125
1	0.860	1	2.75	3.28	2.96	3.28	1.375

General

General use smooth PTFE core hoses.

Features

- Tube I.D. 1/4" up to 1"
- Pressure rating Vacuum to 3200psi (240 bar)
- Min Bend radius 1.5inch (38.1mm)
- Conductive inner lining available

THT Series - Smooth PTFE Core SS Braided Hose

Inside Diameter		Number of Braids	Maximum Working Pressure		Dynamic Minimum Bend Radius		Outside Diameter		Burst Pressure		Weight Per Foot	Weight Per Meter
(inch)	(mm)		(psi)	(bar)	(inch)	(mm)	(inch)	(mm)	(psi)	(bar)		
1/4	6.35	1	3200	221	1.5	38	0.41	10.4	12,800	883	0.1	0.15
3/8	9.53	1	2500	172	2.0	51	0.53	13.5	10,000	689	0.12	0.18
1/2	12.70	1	2000	138	3.0	76	0.67	17.0	8,000	552	0.16	0.24
3/4	19.05	1	1000	69	8.2	208	0.87	22.1	4500	310	0.22	0.33
1	25.40	1	1000	69	12.0	305	1.19	30.2	4000	276	0.51	0.76



Materials of Construction

Part	Material
Tube	PTFE
Braid	SS 304
End Connections	SS 316L

General

Special design for pharmaceutical, Food & beverages and biotech applications. Silicon cover protect the braid from particles or other external contamination and distend high temperatures.

Features

- Tube I.D. 1/4" up to 1"
- Pressure rating Vacuum to 3250psi (224bar)
- Min Bend radius 1.5inch (38.1mm)

THS Series - Silicon Covered Smooth PTFE Core SS Braided Hose

Inside Diameter		Number of Braids	Maximum Working Pressure		Dynamic Minimum Bend Radius		Outside Diameter		Burst Pressure		Weight Per Foot	Weight Per Meter
(inch)	(mm)		(psi)	(bar)	(inch)	(mm)	(inch)	(mm)	(psi)	(bar)		
1/4	6.35	1	3250	224	1.5	38	0.50	12.7	13000	896	0.13	0.19
3/8	9.53	1	2500	172	2.0	51	0.65	16.5	10,000	689	0.15	0.22
1/2	12.70	1	2000	138	3.0	76	0.81	20.6	8,000	552	0.18	0.27
3/4	19.05	1	1000	69	8.2	208	1.02	25.9	4500	310	0.34	0.51
1	25.40	1	1000	69	12.0	305	1.36	34.5	4000	276	0.57	0.85



Tube - PTFE
Braid - SS304
External cover - Silicon
End Connection - SS316

Materials of Construction

Part	Material
Tube	PTFE
Braid	SS 304
External cover	Silicon
End Connections	SS 316L

General

Convuluted PTFE core for extra flexibility with larger IDs. Completely drainable hose. Durable for high pressures and high temperatures with lower profile.

Features

- Tube I.D. 1/2" up to 2"
- Pressure rating up to 1500psi (103bar)
- Min Bend radius 2.5inch (63.5mm)

THC Series - Convuluted PTFE Core SS Braided Hose

Inside Diameter		Number of Braids	Maximum Working Pressure		Dynamic Minimum Bend Radius		Outside Diameter		Burst Pressure		Weight Per Foot	Weight Per Meter
(inch)	(mm)		(psi)	(bar)	(inch)	(mm)	(inch)	(mm)	(psi)	(bar)	(lbs)	(kg)
1/2	12.70	1	1500	103	2.5	64	0.76	19.3	6000	414	0.19	0.28
3/4	19.05	1	1100	76	3.0	76	1.00	25.4	4400	303	0.27	0.40
1	25.40	1	1000	69	5.5	140	1.32	33.5	4000	276	0.39	0.58
1 1/2	38.10	1	700	48	6.0	152	2.03	51.6	2800	193	0.75	1.12
2	50.80	1	525	36	7.5	191	2.46	62.5	2100	145	0.89	1.32



Materials of Construction

Part	Material
Tube	PTFE
Braid	SS 304
End Connections	SS 316L

Expansion Joints



A wide variety of custom-made Expansion Joints are available for different sizes, designs and materials. All specifically designed to meet your system requirements by our expert team and well proven manufacturing capabilities that are subject to the highest testing and quality assurance practices.

For more information: contact your HAM-LET Local Representative

PTFE Hoses - Ordering Information

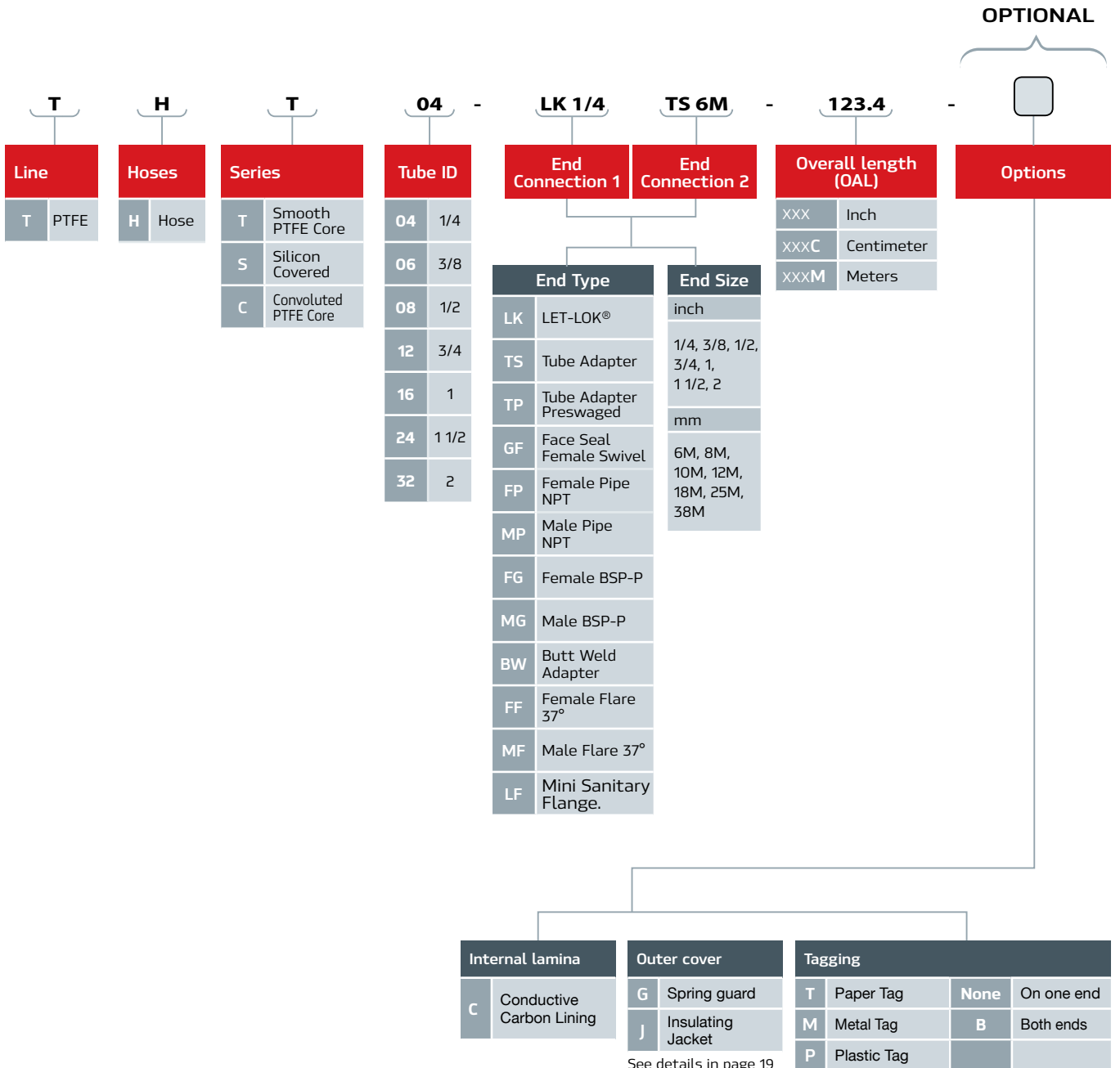

Warning!

The system designer and user have the sole responsibility for selecting products suitable for their special application requirements, ensuring their safe and trouble-free installation, operation, and maintenance. Application details, material compatibility and product ratings should all be considered for each selected product. Improper selection, installation or use of products can cause property damage or personal injury.



HAM-LET USA

12565 West Airport Blvd.
Sugar Land, Texas 77478
Tel: +1 281 5664900
Fax: +1 281 5664910
e-mail: usa@ham-let.com

HAM-LET Canada

3190 Ridgeway Drive, Unit 33
Mississauga, Ontario, L5L 5S8
Tel: +1 905 6089996
Fax: +1 905 6088661
e-mail: canada@ham-let.com

HAM-LET UK

Unit 1, Lindfield Enterprise Park
Lewes Road, Lindfield
Haywards Heath, West Sussex
RH16 2LH
Tel: +44 1444 487555
Fax: +44 1444 487666
e-mail: uk@ham-let.com

www.ham-let.com

HAM-LET Germany

Dornacher Strasse 3a
D-85622 Feldkirchen
Tel: +49 89 90778060
Fax: +49 89 90778070
e-mail: gmbh@ham-let.com

HAM-LET France

Siège Social, Park Avenir
Zone de Sacuny
Avenue Marcel Merieux
bâtiment B7, 69530, BRIGNAIS
Tel: +33 4 78950342
Fax: +33 4 72310576
e-mail: france@ham-let.com

HAM-LET BENELUX B.V.

Industrieweg 30, 7944 HS,
Meppel, The Netherlands
Tel: +31 522237049
Fax: +31 522237040
e-mail: benelux@ham-let.com

HAM-LET RUSSIA

125319 Moscow,
Chernyakhovskogo Str. 16, office 1100
Ham-Let LLC
Phone: + 7 495 651 62 38, +7 495 973 04 31
Fax: + 7 495 651 62 38
E-mail: russia@ham-let.com

HAM-LET Singapore

211 Woodlands Avenue 9 Spectrum II
building #05-88
Singapore 738960
Tel: +65 62578313
Fax: +65 62578315
e-mail: singapore@ham-let.com

HAM-LET Motoyama Japan (HMJ)

TSI Hakozaki Bldg. 4F,
20-5, Hakozaki-cho, Nihonbashi,
Chuo-ku, Tokyo, 103-0015
Tel: +81 3 36685321
Fax: +81 3 36647027
e-mail: hmj@ham-let.com



qr.ham-let.com/hose

This document is proprietary to HAM-LET Group and may not be copied, duplicated or used without the permission of HAM-LET Group. HAM-LET Group reserves the right to make changes to any portion of this document at any time without notice. The information furnished by HAM-LET Group in this document is believed to be accurate and reliable. However, HAM-LET Group assumes no responsibility for its use or for errors or omissions. All company and brand products are trademarks or registered trademarks of their respective holders.